



Better World™



A Better Way A Better World

Sustainability and Social Responsibility Report 2021



Table of Contents

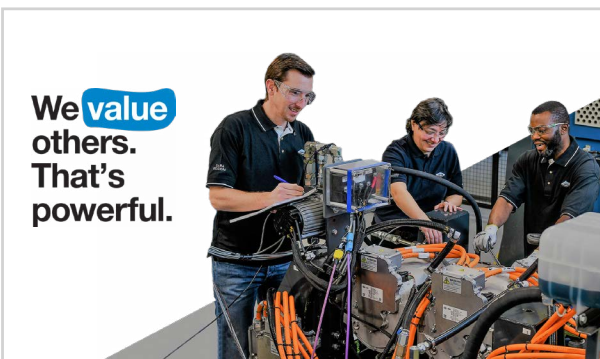

2



36

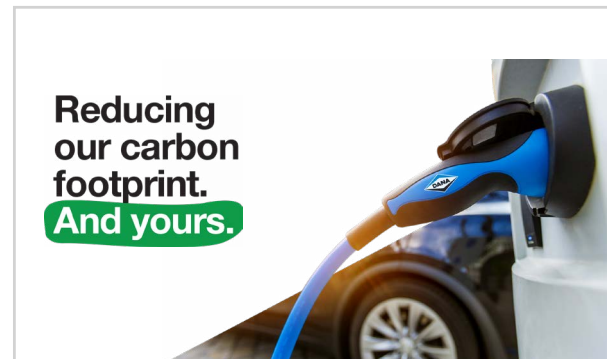

49



54



63



67



76



85

We **value**
others.
That's
powerful.



Dana by the Numbers

Established in **1904**. Employing **40,000** people across **139** major facilities in **31** countries. Shipping to **14,000** customers in **141** countries. Leveraging a global network of **23** technology centers across **9** countries.

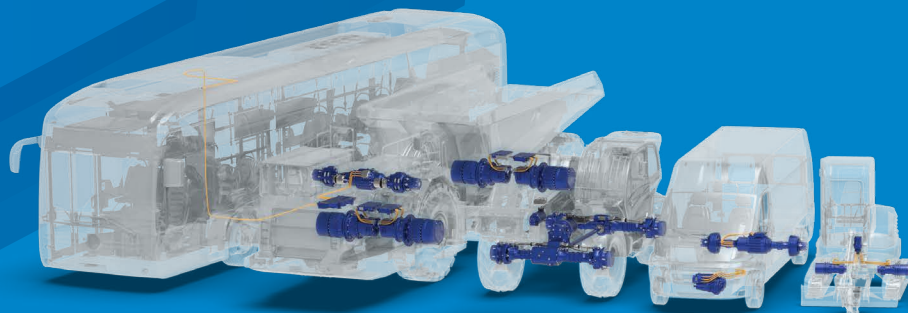

Business Units

Light Vehicle Drive Systems

Dana is a leading supplier of fully integrated drivetrain and electrified propulsion systems for all passenger vehicles. Working collaboratively with original-equipment manufacturers and the aftermarket, we focus on delivering best-in-class efficiency, maximum durability, and superior ride and handling across the globe.

Commercial Vehicle Drive and Motion Systems

Dana is an industry leader in the supply of traditional and electrified systems for medium- and heavy-duty commercial vehicles. We help original-equipment manufacturers and end-market customers achieve the best weight, performance, and efficiency, as well as the lowest cost of ownership, no matter the powertrain configuration.

Off-Highway Drive and Motion Systems

Dana delivers mobile drivetrain and motion solutions for construction, agriculture, material handling, and mining equipment, as well as motion systems for a wide variety of mobile and stationary industrial applications. These customized solutions support vehicles and machines with both conventional and electrified power sources and are designed to deliver innovative technologies that serve customers worldwide.

Power Technologies

Dana provides advanced thermal-management and sealing solutions to all end markets in support of conventional, electrified, and fuel-cell platforms. Leveraging the most cutting-edge technology and manufacturing processes, we deliver custom-engineered solutions designed to optimize efficiency and performance.

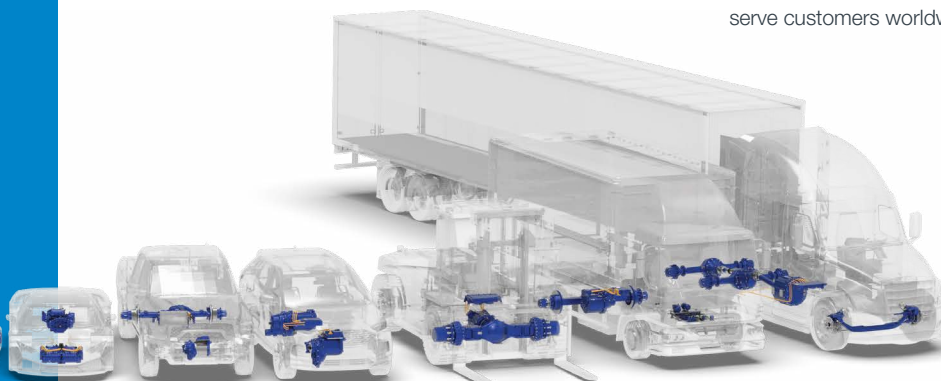

Sales 2021

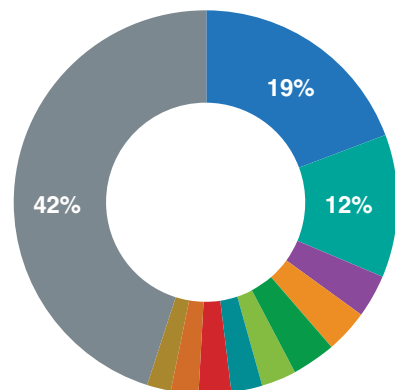

Sales by Customer

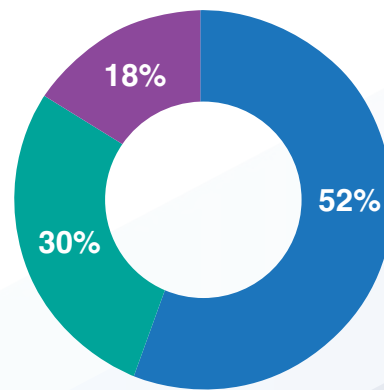
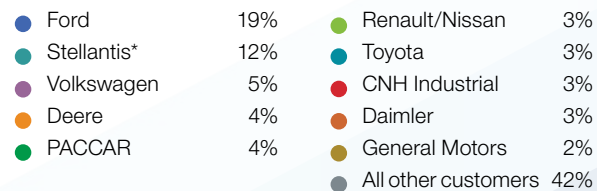

Sales by End Market

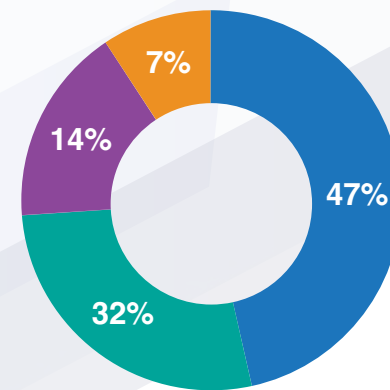
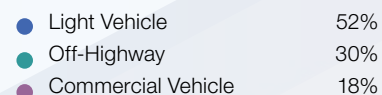

Sales by Region

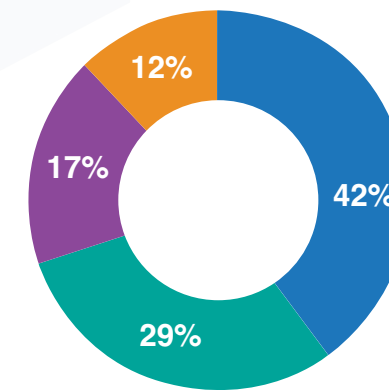

Sales by Segment

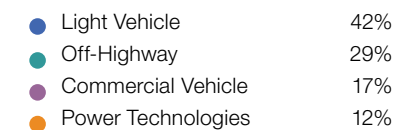

* Includes sales to system integrators for driveline products that support Stellantis vehicles.

Message From Our CEO

Dear Fellow Stakeholders,

I am pleased to share with you Dana's 2021 Sustainability and Social Responsibility Report.

When I think of corporate responsibility, two well-known quotes ring true.

One: "What you do makes a difference, and you have to decide what kind of difference you want to make."

And two: "How wonderful it is that nobody need wait a single moment before starting to improve the world."

At Dana, on both fronts, there is a strong bias toward action.

We recognize that climate change is one of the most significant challenges of our time and believe that mainstream electric vehicles will help to transform the automotive industry and decarbonize the planet.

Leading by Example

Our guiding vision toward a zero-emissions future is at the heart of everything we do, and why we focus on our electrification pursuits.

It shaped our ambitious enterprise strategy to capitalize on our first-mover advantage in electrification.

We continue to strategically invest to secure unparalleled technical competence in designing, engineering, and manufacturing the components of a complete e-Propulsion system in-house.

When we talk of electric motors, these are the heart of the system. The power electronics are the nerve center. The software and controls are the brains of the system. And the core mechanical torque transfer capabilities — from Dana's legacy business — are still the muscle.

When you put this together, Dana stands as the only supplier that has in-house capabilities to deliver these fully integrated systems to the entire mobility market.

This is a fundamental differentiator in supporting a broad range of customers in their adoption of electric vehicles.

In short, Dana has completely repositioned the business to support our customers' clean-energy priorities — across all mobility markets — anywhere in the world.

Half of our new business backlog through 2024 comes from innovating next generation clean-energy technologies and products.



In short, we have completely repositioned the business to support our customers' clean-energy priorities — across all mobility markets, anywhere in the world.

Photo: Jim Kamsickas, Dana Chairman and Chief Executive Officer

Science drives our strategic approach to sustainability — it's crucial to transparently measure, validate, and report on our climate commitments.



This incorporates pioneering efficient electric vehicle systems, shaping market trends, and fast-tracking new electrodynamic products such as motors, inverters, controls and software, chargers, e-Power cradles, battery cooling systems, and bipolar fuel-cell plates.

Taking Action

Within the mobility industry, we have a unique opportunity to lead by example, not only in designing and developing products, but in how we manufacture them to reduce our impact on the environment.

In 2021, Dana announced that we are reducing our global Scope 1 and 2 annual greenhouse gas (GHG) emissions by more than 50 percent by 2030.

Again, this means taking action where it matters most.

- By lowering our overall energy consumption.
- By driving efficiency improvements across our operations.
- By sourcing renewable energy from on-site solar arrays around the world.
- By entering into a renewable energy purchase agreement that will reduce 90 percent of our current U.S. annual electricity GHG emissions.

Your Sustainability Goals

With 139 major facilities strategically located across 31 countries on six continents, we are committed to building a carbon-neutral supply chain.

Our climate actions also impact customers' sustainability goals. We therefore closely benchmark and monitor our supplier base to improve the sustainability performance across our supply chain — including the analysis of global Scope 3 GHG emissions.

We regularly score our suppliers based on several important attributes, including their ESG rating. This recognizes that our performance, and the performance of our supply chain, is important to our customers and positively impacts their sustainability objectives.

It's a high bar. And we keep raising it.

Transparent, Verifiable Claims

We are committed to openly disclosing our ESG commitments and progress, and to being led by science-based methods.

It demonstrates that we are serious about the actions that we are taking to help improve the environment.

We will remain an industry leader by joining the Science Based Target initiative (SBTi), a global “gold standard” organization, validating ambitious, science-based emissions reduction targets.

We are proud to partner with SBTi’s member organizations — Carbon Disclosure Project, United Nations Global Compact, World Resources Institute, and Worldwide Fund for Nature — to drive sustainable best practices and lead the way to a zero-carbon economy.

In reporting annually to the Carbon Disclosure Project, a global platform working with organizations of all types to drive positive environmental changes — we are proud to support their important mission to collect, measure, and reduce global GHG emissions.

40,000 Strong

At Dana, we treat people with respect. We rise by lifting others.

Dana’s higher purpose is lived by 40,000 employees working together toward a better tomorrow for our customers and communities.

Our vision, “Powering Innovation To Move Our World,” is a guiding belief that expresses the strength and reliability of our global family and embraces our core capabilities linked to world-class innovation and customer centricity.

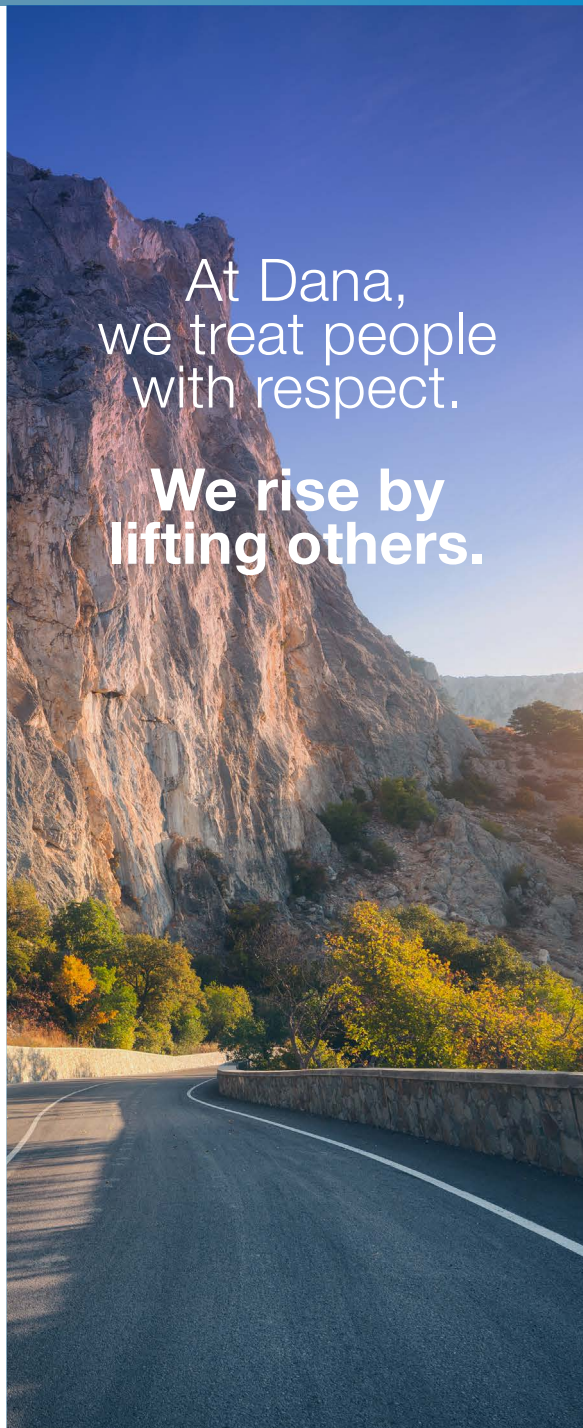

At Dana,
we treat people
with respect.

We rise by
lifting others.

This is accomplished through our core beliefs, which are summed up as —Valuing Others, Inspiring Innovation, Growing Responsibly, and Winning Together.

Combined, these statements represent what we stand for and are the foundational elements underpinning our company theme — *People Finding A Better Way*.

We continuously strive to foster a culture where all ideas are welcomed, and our employees always feel safe and empowered.

Global Recognition

During 2021, we were named among *America’s Most Responsible Companies* by *Newsweek* for three consecutive years reflecting our culture of doing business with the highest ethical standards.

This acknowledgment recognizes, among other things, our commitments to sustainability and social responsibility, our communities, employee health and wellness, and inclusion and diversity. It also spotlights the work we do around the design, sourcing, and manufacturing of clean-energy products.

We create empowering environments for our employees through our “One Dana” teamwork and people-first practices.

This has led to independent recognition from the *Top Employers Institute* and the *Great Places*

To Work Institute across Dana operations in Belgium, China, Hungary, India, Italy, Lithuania, Mexico, the Netherlands, Switzerland, the United Kingdom, and the United States.

Our 91-position increase on the *Drucker Institute’s List of America’s Best Managed Companies 2021* recognizes excellence in the customer satisfaction, sustainability, and social responsibility categories — and we thank our customers who put their faith in Dana every day.

Above all, our people value creativity, integrity, inclusion and diversity, and place a focus on customer success that underscores everything we do at Dana.

They embrace our commitment to living a higher purpose.

I am humbled by their talent and grateful for their work advancing more sustainable practices that do the right thing by people and our planet.

My personal best,

James K. Kamsickas
Chairman and Chief Executive Officer



2 billion

customer miles driven with Dana TM4™ electric motors



20

customer and industry honors in 2021

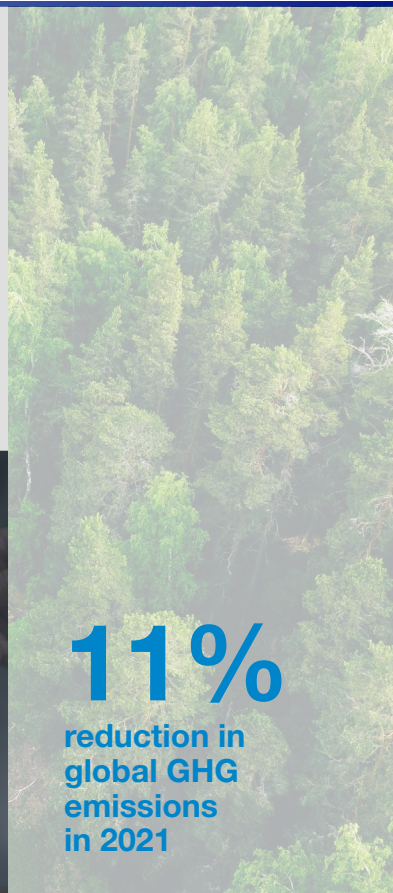

11%

reduction in global GHG emissions in 2021



750+

global efficiency projects reducing GHG emissions, waste, and water consumption



100%

of our major manufacturing facilities to be ISO 45001 certified in 2022



50+

years of electrification experience

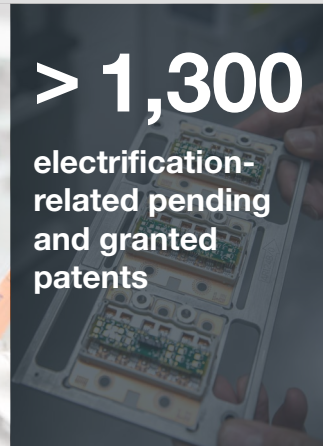

> 1,300

electrification-related pending and granted patents



> 50%

Commitment to reduce Greenhouse Gas (GHG) global emissions more than 50 percent by 2030



90%

of U.S. electricity demand to be addressed by wind project



23

technology centers dedicated to breakthrough innovations across 9 countries

Safety First

At Dana, we care deeply about health and safety.

This impacts everyone of our employees, customers, suppliers, visitors, contractors, and the community.

We believe that Dana has an essential accountability to safeguard life, health, property, and the environment — and we achieve this by consistently committing to excellence in safety, health, and security management through the prevention and elimination of hazards.

By using effective feedback and positive recognition, we actively promote and pursue safety in all that we do. Our “Safety First” approach requires a daily, focused effort.

SafetyFirst
All Day Every Day

Tone at the Top

All successful safety programs start with leadership commitment with clarity on roles and responsibilities throughout the organization.

Dana’s approach to health and safety focuses on people, culture, performance, and results. Behavior is key to each of these elements — whether it’s management, team, or individual actions.

Safe work environments are part of our culture. It's just how we do things.

The role played by leadership provides a critical link to ensure the effective development and implementation of safety processes.

Nevertheless, Dana’s health and safety program requires all employees to take an active role in leading, guiding, and assisting safety awareness, hazard control, and loss prevention.

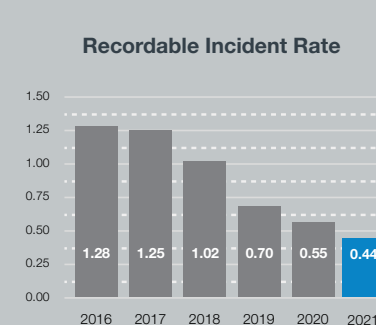
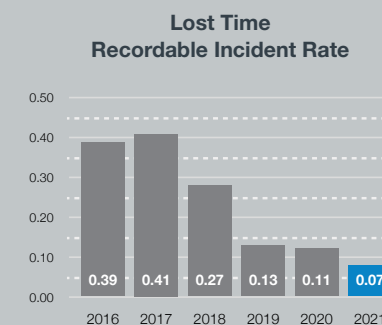

Reaching ISO 45001 Certification Goal

We believe in a formalized safety management system and are serious about employee safety and safe working conditions.

Dana's leadership team is committed to getting all of our major manufacturing facilities registered to the world's first international occupational health and safety standard — the International Organization for Standardization (ISO) 45001.

As of December 31, 2021, 95% of Dana's major manufacturing sites had achieved this certification— establishing an effective occupational health and safety management system that can be integrated with other requirements to achieve our strict health and safety objectives.

ISO 45001 certification also facilitates internal improvements and provides third-party validation that Dana is focused on the most important piece of our sustainability and social responsibility program — our people.

We plan to complete certification of all major manufacturing facilities in 2022 and remain

committed to verified and audited occupational health and safety management system excellence.

Regarding environmental management systems, 98% of Dana's major manufacturing sites are ISO 14001 certified and we will be 100% certified this year.

In 2021, an additional 26 manufacturing sites achieved ISO 45001 certification. By year-end 2022, we will be 100% certified.

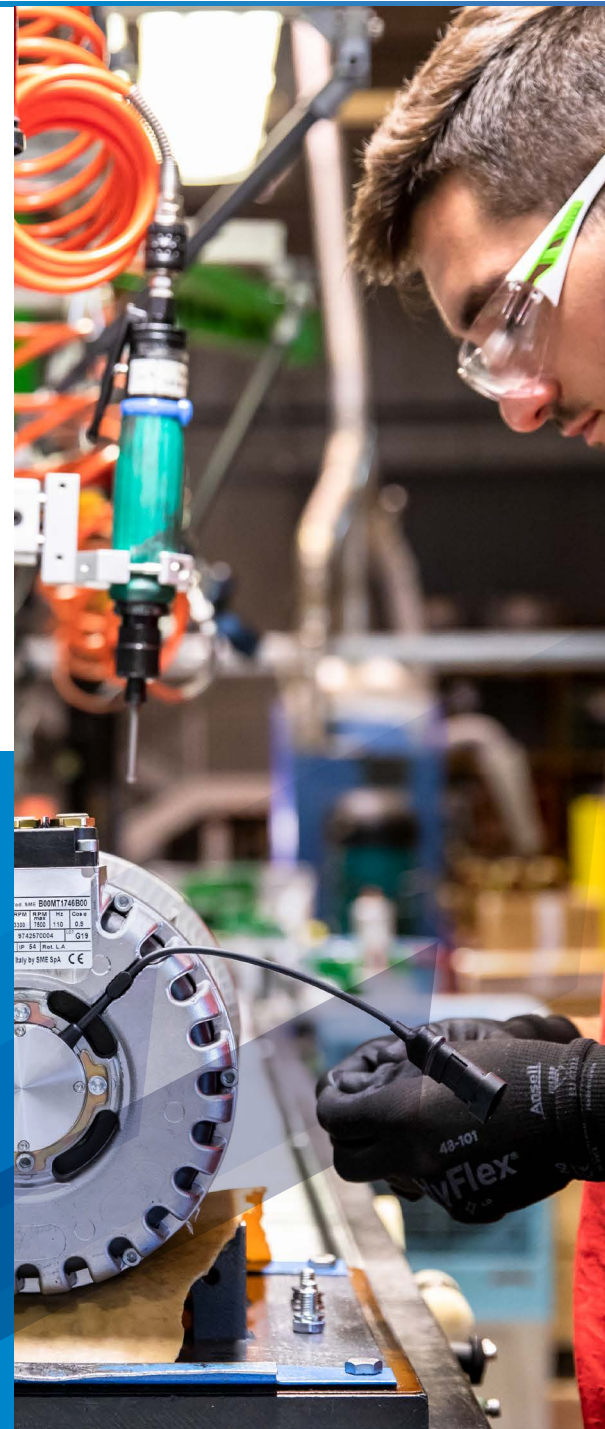

Safety Certified Program

Dana's Safety Certified program provides a platform for all employees to advance through multiple tiers of safety training.

During 2021, employees successfully completed more than 23,000 safety training programs as part of this initiative.

Before undertaking certification training, our people first participate in Safety 101, featuring introductory modules on safety culture, safe behaviors, Dana's "Life Safety Rules," and safety resources.

Dana's "Life Safety Rules" Icons



Focus on Safety Education

A fundamental level of safety awareness is needed for employees to avoid creating situations that could place themselves or others at risk — and is essential to the success of an effective health and safety program.

This requires an understanding of workplace risks; how to identify, report, and control them; and it's why Dana makes safety education a top priority and an integral part of all new employee orientation programs.

Training elements include:

- The importance of methods used to recognize, evaluate, and control workplace risks, including the prevention of unsafe conditions and unsafe acts.
- The employee's rights and responsibilities in the company's health and safety system.
- A thorough review of all applicable company safety rules, policies, and procedures; particularly Dana's "Life Safety Rules," as well as those applicable to each work area.
- A full understanding of the importance of open communications in the health and safety management process.
- Any special risk information specific to the employee's work.

Additional qualification training is necessary on an on-going basis to help ensure that every employee is fully capable of performing all expected tasks in their work area in a safe and effective manner.

Caroline Lange

Continuous Improvement Supervisor
Operational Excellence Team
Gravataí, Brazil

No matter how good you get, you can always get better.
And that's the exciting part.

My work focuses on operational excellence which means looking at things like employee participation, team learning, and motivating our people to solve problems using Dana Operating System standard tools.

We are always looking for ways to enhance efficiencies across thousands of Dana projects by focusing on safety, quality, processes, innovation and more.

Over my seven years at Dana, every day we face different, often very complex, challenges. It's so gratifying to work in an environment where we have the support to change things and can count on others to work as a team.

Truly, People Finding A Better Way!

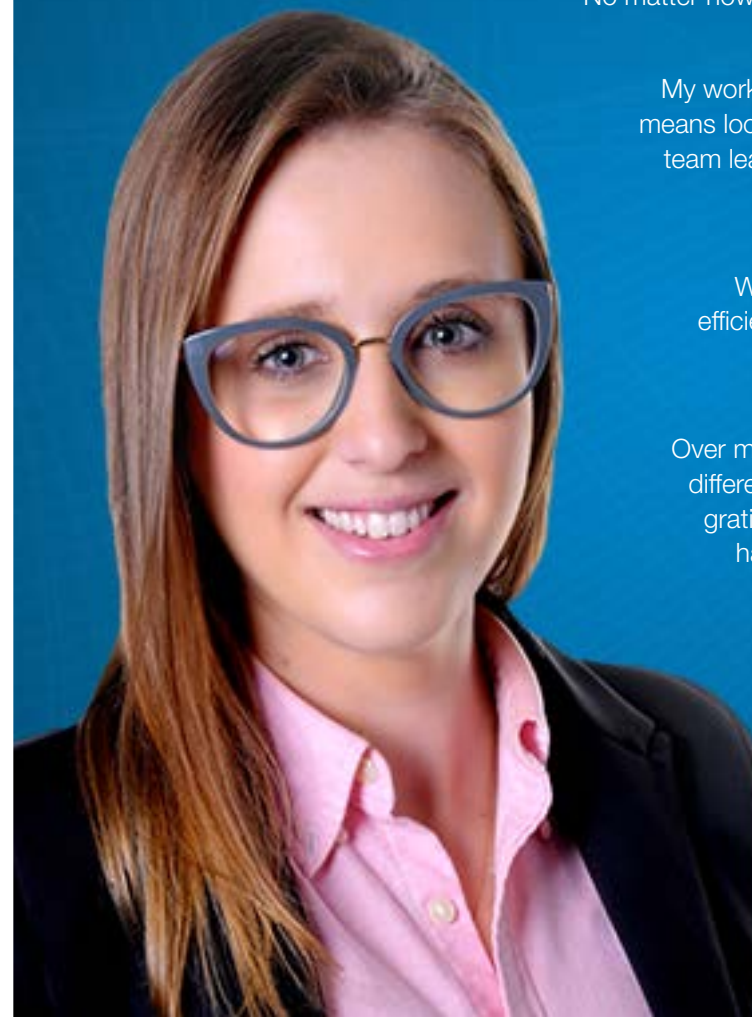

1 Million+ Hours

Without a Lost-time Incident in 2021

North And South America

In 2021, 27 of our plants in North and South America achieved significant milestones for working safely.

1 Million+ Hours

- Bucaramanga, Colombia
- Cambridge, Canada
- Campinas, Brazil
- Gordonsville, United States
- Gravataí, Brazil*
- Lafayette, United States
- Lisle, United States
- Lugoff, United States
- Oakville, Canada
- Sorocaba, Brazil
- Tlaxcala, Mexico

2 Million+ Hours

- Columbia, United States
- Gravataí, Brazil*

3 Million+ Hours

- Louisville, United States
- Monterrey, Mexico
- Paris, United States
- Pottstown, United States
- Querétaro, Mexico*
- Tlalnepantla, Mexico

4 Million+ Hours

- Fort Wayne, United States
- Grand Bourg, Argentina
- Mount Forest, Canada
- Querétaro, Mexico*
- Toluca, Mexico

5 Million+ Hours

- Chihuahua, Mexico
- Jundiá, Brazil
- Tlalnepantla, Mexico*



Data represents hours worked without a lost-time incident recorded as of December 31, 2021.
 *Indicates instances where there is more than one Dana facility in a particular city.

1 Million+ Hours

Without a Lost-time Incident in 2021

Europe, Africa, and Asia

In 2021, 30 of our plants in Europe, Africa, and Asia achieved significant milestones for working safely.

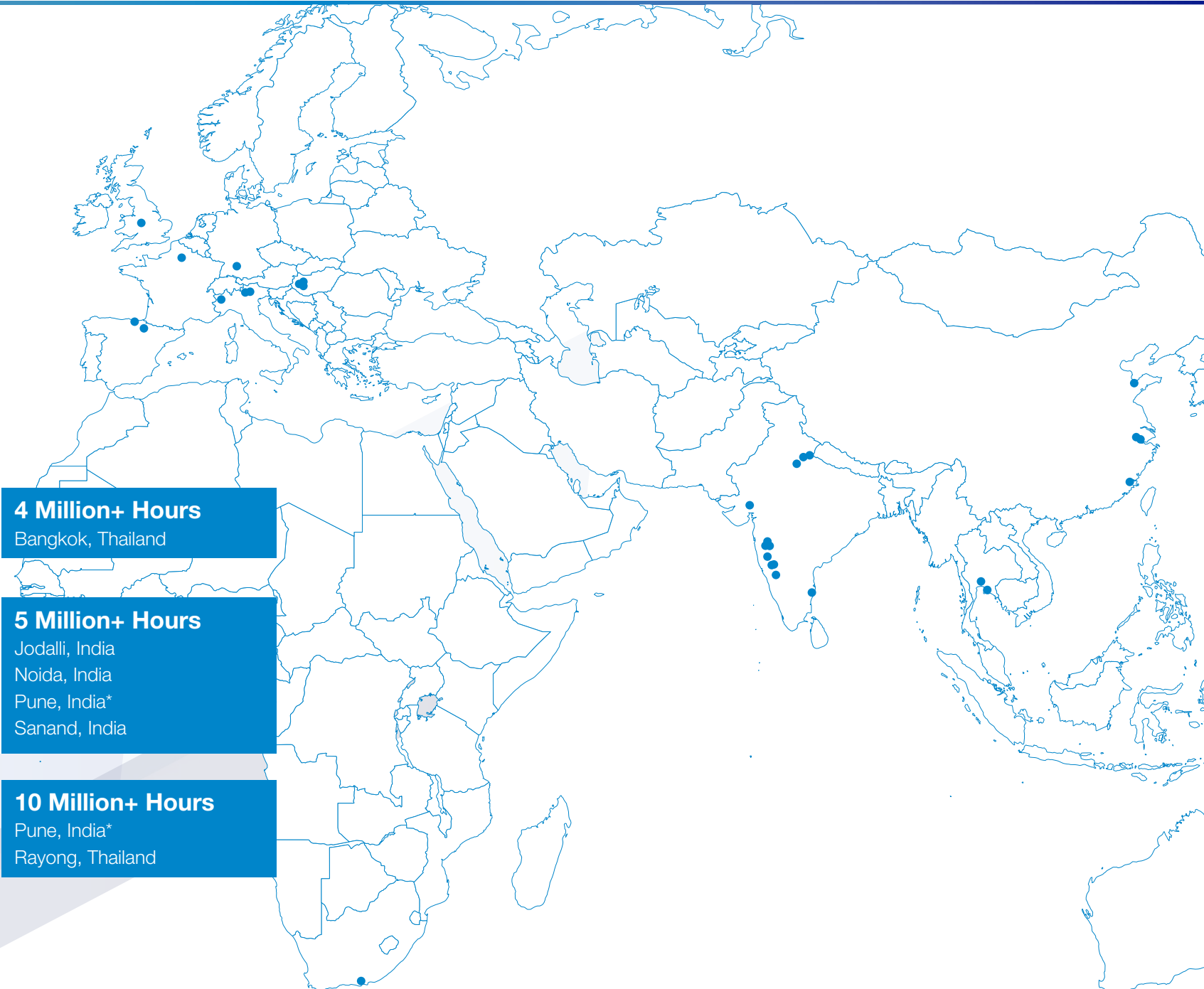

1 Million+ Hours

- Guiscard, France
- Gyor, Hungary*
- Gyor, Hungary*
- Gyor, Hungary*
- Itziar, Spain
- Luserna, Italy
- Pamplona, Spain
- Pune, India*
- Rovereto, Italy
- Rudrapur, India
- Uitenhage, South Africa
- Weifang, China
- Wuxi, China*

2 Million+ Hours

- Arco, Italy
- Belgaum, India*
- Birmingham, United Kingdom
- Chennai, India
- Neu Ulm, Germany
- Pantnagar, India

3 Million+ Hours

- Belgaum, India*
- Fuzhou, China
- Satara, India
- Wuxi, China*

4 Million+ Hours

- Bangkok, Thailand

5 Million+ Hours

- Jodalli, India
- Noida, India
- Pune, India*
- Sanand, India

10 Million+ Hours

- Pune, India*
- Rayong, Thailand

Data represents hours worked without a lost-time incident recorded as of December 31, 2021.
 *Indicates instances where there is more than one Dana facility in a particular city.



CEO Safety Award 2021

Toluca, Mexico

The CEO Safety Award goes to the facility that demonstrated the most outstanding safety performance over the past year.

This year's winner — Dana's Toluca facility in Mexico — has done an outstanding job making safety a top priority.

A strong safety-first culture has created a highly engaged workforce where everyone views safety as a way of life and not just as a system or process.

Highlights include:

- Over 4.5M hours worked without a lost workday incident through year-end 2021.
- Implementation and certification of the world's first international occupational health and safety standard — the International Organization for Standardization (ISO) 45001 — in addition to certification of environmental management system ISO 14001.
- Recognition from the Mexico Labor Department verifying the facility as a "Safe Industry."

- Deployment of active material handling and ergonomics processes to address manual tasks with ongoing reviews covering lift assist equipment, custom stands, and shelves for material handling, among others.
- Exceptional commitment to Dana's Safety Certified Supervisor initiative.
- Certification of Toluca as a "Great Place to Work" from the Great Places To Work Institute.

Safety is a shared responsibility, a partnership among safety, operations, maintenance, engineering, the Toluca employee union, and HR teams — who are genuinely committed to fostering a culture of safety in everything they do.

Together they have built an innovative mindset that promotes a stop-and-fix mentality where everyone is quick to intervene, take a proactive approach, and implement best practices that engineer safety into every process throughout the plant.

Employment Data 2021

Gender

Employees by Employment Type and by Gender

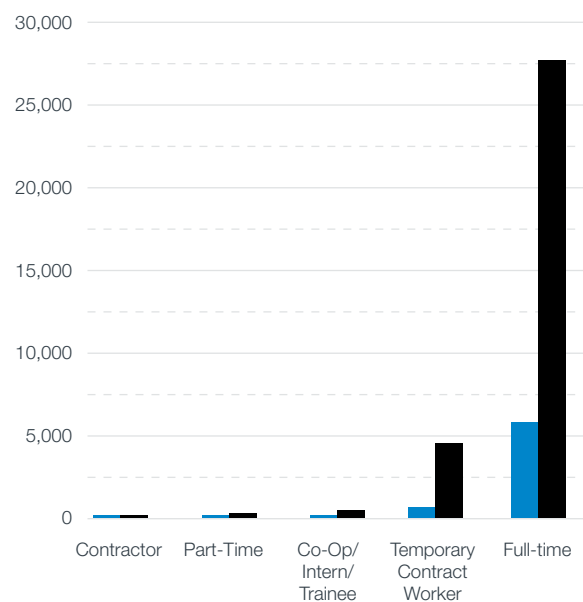

Employees¹



New Hires



Attrition



Female Male

Region

Employees¹



New Hires



Attrition



North America Europe Asia Pacific South America

Age

Employees²

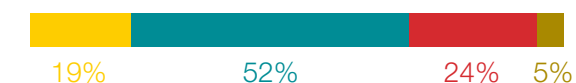

New Hires²



Attrition²



Under 30 30 - 50 Over 50 Unknown/Not Provided

¹ Per headcount policy, vendor service workers, JV unconsolidated, employees on unpaid leave or layoff are excluded from headcount

² Date of birth is not available for certain types of employment classifications (e.g., contractors) and therefore in these instances age is unknown or not provided



Mukul Rustagi

Senior Manager, Human Resources India
Noida, India

In India, we were recently awarded “Top Employer” from the Top Employers Institute, recognizing Dana’s strong values and people-first workplaces.

Our culture — expressed through Value Others, Inspire Innovation, Grow Responsibly, and Win Together — shows what we care about and what it means to do business the Dana way.

For me, a great workplace is one where employees trust each other, enjoy the company of the people they work with, and take great pride in what they do.

This sense of purpose comes to life each day with 40,000 people in 31 countries working together as global leaders in drivetrain and e-Propulsion systems.

Inclusion and Diversity: The Dana Way

At Dana, we are committed to advancing and reflecting the communities we serve.

This means building teams that mirror real-world life experiences and valuing curiosity and innovation from all our 40,000 employees across 139 major facilities in 31 countries.

Respectful and Inclusive

A mindset of inclusion and diversity reminds us that we all belong. We are committed to providing safe, respectful, and inclusive workplaces where everyone can contribute, participate, and thrive.

A shared understanding of inclusion is what allows Dana colleagues — with their unique talents, perspectives, and preferences — to know they matter.

While inclusion refers to the Dana behaviors that ensure people feel welcome, diversity refers to the qualities that make people unique.

We respect and appreciate what makes colleagues different, including age, gender, ethnicity, religion, disability, sexual orientation, education, national origin, and other dimensions of diversity that are not as readily apparent.

This means understanding one another and ensuring people truly value their differences, placing positive value on diversity in the global workforce and the community. For us, this is the who and the what.

Who is being recruited, who is being promoted — and how we can build a better world by incorporating everyone's characteristics.

Five Pillars

Dana's inclusion and diversity strategy is guided by five pillars.

Representation

We set goals, building internal and external talent pipelines, and expanding our diversity recruitment, retention, and promotion efforts to increase varied representation.

We use transparent, data-driven talent practices and decisions to help mitigate bias and equip our leaders with the tools, information and support necessary to achieve their goals.

Education

We continue our strong focus on inclusion and diversity education for all Dana employees to ensure that they have the cultural awareness and understanding necessary to successfully build and retain diverse and inclusive teams.

We connect with third-party organizations such as the Center for Automotive Diversity, Inclusion and Advancement, among others, to provide our Business Resources Groups (BRGs) with tools to promote leadership within their organizations and resources designed to inform and engage.

Our partnerships with CEO Action for Diversity and Inclusion and the Charta der Vielfalt in Europe provide materials to support Dana's education journey.

Development

We offer development programs to empower employees in realizing their career aspirations. We support them with their career progression and provide them with a clear understanding of how to build their careers at Dana.

We also partner with consulting firms to create world-class development programs including a focus on mentorship and sponsorship. Importantly, these programs align with our annual performance appraisal and individual development planning process. It's not just what we achieve — but how we get there that counts.

Community

Dana communities are places where we live, work, and play. We partner with local communities around the world to advance more diverse hiring practices.

We champion our BRGs which are voluntary, employee-led groups formed around shared identity, interests, and pursuits. They represent and support the diverse communities that make up our workforce and are open to all employees.

We know that every decision counts. Therefore, in sourcing materials for the products that we make, we drive sustainability and social responsibility as a key part of every purchasing outcome.

This includes our detailed evaluation process analyzing key considerations such as inclusion and diversity considerations (diversity ownership of our supplier base) as well as sustainability and social responsibility factors.

Cross-functional Collaboration

We focus on cross-functional collaboration to ensure that inclusive and equitable structures and work practices are embedded in all Dana processes — with a focus on people and supplier development, compensation, engagement, attraction, and retention.



Inclusion and Diversity Governance Committee

Dana's Inclusion and Diversity Governance Committee is structured by region — Asia Pacific, Europe, Latin America, and US/Canada — and aims to research, develop, and propose mechanisms and strategies to continually enhance a supportive, inclusive, and diverse workplace.

- Assisting Dana leadership in driving diversity strategy, goals, and key milestones.
 - Identifying and formulating recommendations for programs, policies, and work practices that affect recruitment and retention of a diverse workforce.
 - Advancing transparent processes to access developmental and advancement opportunities, and prioritizing education programs that build inclusivity and diversity competencies and awareness.
 - Acting as advocates of Dana's inclusivity and diversity strategy.
- Progress by the Inclusion and Diversity Governance Committee is reported on at least five times annually to Dana's Board of Directors.



Women Apprentices Powering Brazil Operations

As part of a national effort to attract more women to manufacturing positions, Dana Brazil took the lead in establishing the Women Apprentices in Operations Program — offering paid training to prepare women for work at Dana.

This initiative aligns with the United Nation's sustainable development objective of ensuring inclusive and equitable education and promoting lifelong learning opportunities for all.

Dana joined forces with SENAI (a federal government industry support group) and CIEE (offering internship programs for companies throughout Brazil) to create a training curriculum advancing topics such

as metrology, technical drawing, quality, the 5S System, overview of Dana products, and more.

An internal sponsor and HR business mentor accompanied participants for the first three months, supporting as necessary thereafter. We wanted to establish a peer-to-peer support structure, where sharing experiences and best practices were encouraged.

The first group of apprentices started at Dana's Gravataí in November 2021 and the program is now expanding to our operations in Jundiaí, Campinas, and Sorocaba this year.

Business Resource Groups: From Strength to Strength

We continue to promote and provide visibility to our Business Resources Groups (BRG) to help amplify the experience and resourcing for members of each of our internal communities.

As a global organization, our people bring perspectives and opinions sourced from different cultures, backgrounds, and experiences that help to shape the Dana family.

Listening to diverse voices and opinions gives Dana strength, enabling us to solve problems faster, think outside the box, and ultimately drive continuous improvement and profitable growth.

Inspiring the Best

Our expanding BRG network lends a voice to the diversity we have across all of Dana and increases the engagement of both our current and retired employees. In addition, they help to fulfill our commitment to being a good corporate citizen.

By embracing inclusion and diversity, we create an environment that inspires the best from everyone and maximizes the value of our most important asset — each other.

These seven BRGs are executive leadership-supported, employee-led initiatives with the mission to inspire growth and innovation and foster inclusion and diversity for all employees.

- African American Resource Group
- Dana Alumni Resource Group
- Dana Women's Network (DAWN) Resource Group
- Green Team Resource Group
- LGBT + Allies Resource Group
- Military and Veterans Resource Group
- New To Dana Employee Resource Group



Dana's African American Resource Group from Maumee, Ohio, United States, presents a \$15,000 scholarship to Logen Love, Class of 2021 graduate from Rogers High School in Toledo, Ohio.

POWER Up

DAWN also partnered with multi-national accounting firm EY to present POWER Up — a leadership and personal brand development experience.

Consisting of three half-day programs, POWER Up was offered virtually and included 150 participants around the world.

It focused on helping women identify tangible actions and steps they can take to advance their careers, ensure their personal brand is projected consistently in line with career goals, and develop peer-to-peer relationships across the organization.



Bridget Karlin
Member, Dana Board of Directors
Senior VP of Information Technology - Kaiser Permanente

The event commenced with a keynote speech from Bridget Karlin, member of Dana's Board and senior VP of information technology at Kaiser Permanente. Panelists and participants described how, as women leaders, they leveraged the POWER Up acronym to enhance their career.

- P** Project confidence authentically by exhibiting a firm belief in your abilities
- O** Own your career by mindfully taking control of your career and life
- W** Widen you network by identifying and engaging mentors and sponsors
- E** Elevate your communication with clarity, self-assurance, and intent
- R** Realize your purpose by knowing who you are and what you believe

Dana Women's Network

DAWN advances the promotion of professional networking and career development opportunities through mentoring, education, and philanthropy for women across varying experience levels.

In 2021, DAWN's United States members volunteered with Girls on the Run and ran a 5K in support of this life-changing program for 8 to 13 year-old-girls that promotes girl empowerment.

DAWN members also participated in many events around the world, including volunteering to inspire girls to become the next generation of engineers, doctors, and researchers.

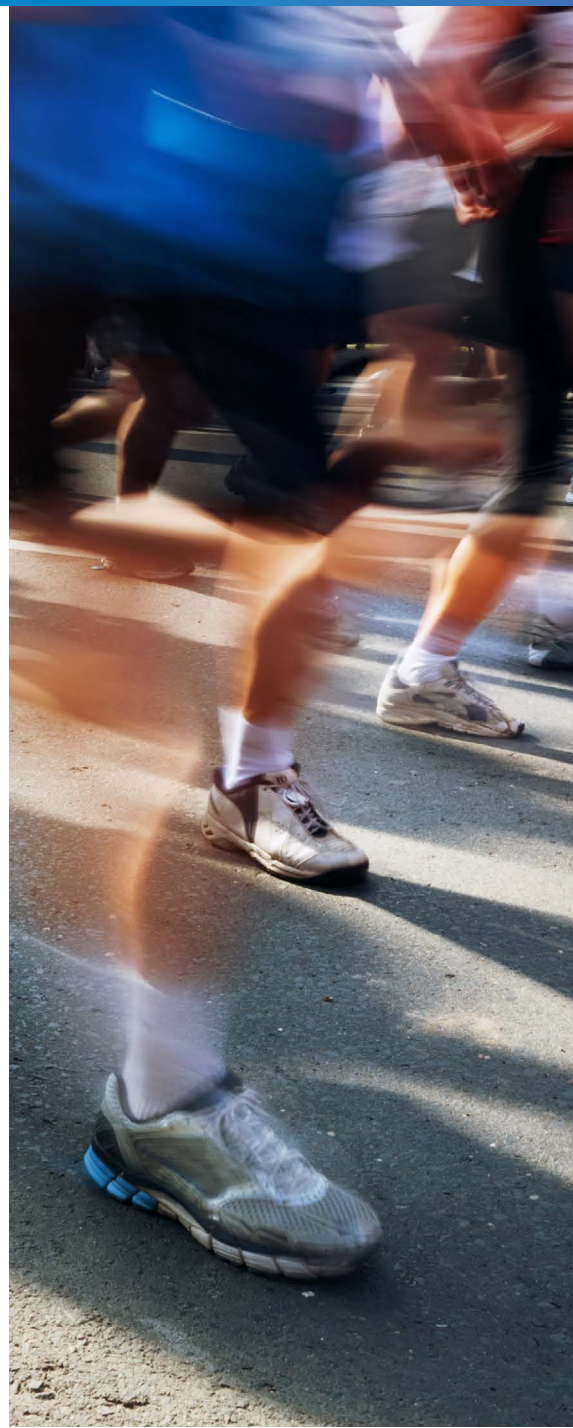

Military and Veterans Panel

In May, Dana's Military and Veterans (M&V) BRG hosted a lunch and learn panel led by retired Dana Board Member and former Secretary of the U.S. Navy, Ray Mabus.

Topics discussed included military culture, how military skills translate to life after service, and how organizations can better support veterans.

During the year, additional highlights from the group incorporated strengthening the Dana relationship with Shift.org, volunteering for mentorship programs with service members transitioning from the military, introducing a M&V BRG coin to raise funds for veteran organizations with the United Way, and co-sponsoring a 5k-run to raise funds for suicide prevention.



Raymond E. Mabus, Jr.
Retired Member, Dana Board of Directors
Founding Principal and CEO of The Mabus Group

At Dana, Culture Runs Deep

Dana’s agility and innovation has powered a remarkable transformation over the last decade.

We have advanced from 24,000 people in 26 countries with \$5 billion in sales in 2009 to 40,000 people in 31 countries and some \$9 billion in sales in 2021 — and are now positioned as a global leader in drivetrain and e-Propulsion systems.

This remarkable transition is powered by a deep appreciation of what company culture means and why it’s important.

We express this in Dana’s company theme — *People Finding A Better Way* — which is our North Star for employees, customers, and communities.

These words represent everything we do and how we do it. It’s Dana’s dynamic culture, diverse in makeup, thinking, and disciplines. It’s our passion to solve, to find a better way.

To come at things from a different angle and puzzle the pieces together to deliver a greater result.

To make the world around us better.

Vision, Mission, Values

In 2021, we decided to seize the moment and refresh the words expressing Dana’s vision, mission, and values that reflect how we truly are *People Finding A Better Way*.

This employee-led initiative involved global focus groups and feedback from customers, suppliers, and communities around the world.

Lita Guo

Human Resources Manager
Chongqing, China

During my four years at Dana, I always felt the backing to help me be successful. I’ve been encouraged to take responsibility. To learn new skills like developing strategy or advancing negotiations.

I know that I have the support of my mentors and that I can take true ownership of my career development.

Our team builds rear drive units for light vehicles. Here, the idea of “winning together” is very strong.

It comes across in the way our office and plant workers teamed up during this very challenging pandemic.

But I also see it in how the team engages with our days of understanding or during discussions on diversity.

I really feel that we have a safe, inclusive environment where unique perspectives are valued.



Our Vision

Our vision statement captures what propels us and how we create value for our shareholders, customers, and people.

Dana's vision statement is ...

Powering Innovation To Move Our World

This is our destination as a company.

It expresses strength and reliability with a bias toward action. It showcases power conveyance and energy-management expertise — putting Dana at the heart of a world in motion.

It spotlights our scale and global reach as a driving force in everyday life. A whole greater than the sum of its parts.

This is us.



Powering Innovation To Move Our World

Driving stakeholder value by:

- powering vehicles and machines around the world;
- shaping sustainable progress through invention and execution; and
- making the amazing happen wherever people live, work, and play.

This mission is embodied in our company theme:

People Finding A Better Way[®]

Our Mission

As we continue to power into e-Drive, a simple, action-orientated statement captures what propels us and how we create value for our shareholders, customers, and people.

In short, our mission explains what we do and why we do it.

Our Values

As we power these vehicles and machines that move our world, we treat people with respect.

Dana's culture is also expressed through our revitalized values, which include beliefs that drive the behaviors upon which we must continue to build to succeed.

These values express what we care about and what it means to do business the Dana way.

Value Others

We value people by embracing inclusion and diversity, treating others with respect, and putting safety and integrity at the heart of everything we do.

Inspire Innovation

We reimagine what's possible, working with a bias toward action and creativity, and operating with a relentless focus on innovation, product safety, and customer success.

Grow Responsibly

We look for ways to advance a safer, more sustainable future through a balanced approach that considers the people we encounter, the products we develop, and the planet that enables us to do our work.

Win Together

We pursue quality and excellence in a safe, inclusive environment where unique perspectives are encouraged and valued by collaborating across a global network of expertise covering all mobility markets.

Value Others
Inspire Innovation
Grow Responsibly
Win Together

Celebrating International Women's Day

The celebration of International Women's Day shares a universal goal — no matter where you are — to show support for all women.

Dana Women's Network mobilized the global Dana community to participate in International Women's Day by wearing purple and identifying what they #ChooseToChallenge.

Since we were maintaining social distance during the pandemic, employees submitted photos of themselves wearing purple and taking the pledge.



Day of Understanding

Dana's Day of Understanding was coordinated as part of our CEO Action for Diversity and Inclusion pledge.

This pledge outlines a specific set of actions organizations will take to cultivate a trusting environment where all ideas are welcomed and employees feel comfortable and empowered to have discussions about inclusion and diversity.

At Dana, each location selected a day from mid-April to mid-May to engage with each other on inclusion and diversity.

Activities included a Courageous Conversation Wheel, which participants could spin to use as conversation starters on various inclusion and diversity topics. There were videos with discussion

guides and employees signed a personal inclusion and diversity pledge to help drive inclusive behaviors in their everyday life.

As an expansion of the Day of Understanding, Inclusion Forums were created to facilitate ongoing conversations.

Panels of military veterans and technology leaders provided employees with innovative ways to enhance Dana's culture — including how to model honest dialogue about inclusion and diversity and how it can help teams work better.

These training programs call for each of us to take a personal look at our own predispositions, conscious or non-conscious, and to engage in practical steps to recognize and overcome them.

People Development

At Dana, we want our people to know that they can be innovative; receive career development, fair wages, and benefits; and see their contributions being valued — contributing to the long-term success of their career goals and to Dana's achievements.

To engender a spirit of collaborative innovation, we support open communication opportunities, allowing employees to deliver feedback, including engagement surveys, skip-level discussions, and interaction with the leadership team.

2021 Programs

Once a new employee is onboarded and trained, retaining them means spotlighting life at Dana — showcasing our work environments, culture, development opportunities, and employee recognition.

Dana's development programs offer immersive, hands-on learning experiences for recent college graduates to jump-start a career in finance, human resources, purchasing, and engineering.

In the United States for example, participants on the program work in three assignments in different areas of their respective function over a five-year period to accelerate opportunities for leadership roles.

During 2021, we provided on-demand programs for employees around the world to gain skills and knowledge without having to leave their desk.

These trainings were provided through several platforms:

SkillPort

A third of the salaried population completed training in Dana's SkillPort portal, which provides a wide variety of instruction to employees looking to increase their skills in topics such as management, communication, inclusion and diversity, quality, and safety.

Employees earned badges to show that they have completed journeys in Leadership Development, Finance for Non-Financial Professionals, and several other courses.



Roos Claeysens

Program Management Director, Heavy Vehicle Brugge, Belgium

I've always been inspired by the purpose and passion we have at Dana. We innovate in our applications, our workspace, and our technology to make the world a better place.

Whether it's for vehicles in the construction, material handling, or mining sectors — there's nothing quite like the sense of achievement when you see your work making a real-world impact, at such an impressive scale.

We take an innovative concept, mature it through teamwork into a technology that advances our customers' electrification journey, and then coordinate manufacturing engineering, production, assembly, and aftermarket services.

I am so proud to drive continuous improvement at an organization where unique perspectives are valued, to accelerate innovative program management systems, and play my part in shaping sustainable progress through invention and execution.



FranklinCovey

Production supervisors in facilities across the United States completed 7 Habits of Highly Effective People™ and Unconscious Bias® courses during 2021, increasing their capacity to manage employees through challenging conditions.

GlobeSmart®

This platform built cultural competency and helped employees to communicate more effectively with our global organization — particularly as the pandemic impacted traveling and face-to-face communications.

Learning Journeys

“Learning Journeys,” a monthly selection of online training sessions, was an important asset for the development of our employees during the year.

The subjects chosen each month encompassed career progression planning to support the development and talent review process, mid-year review cycle, and preparations for effective performance discussions at the end-of-year review.

Learning Journeys addressed the issues many of our people were facing while working from home. We looked at the tools for working remotely, virtual

teamwork, managing stress, resilience, as well as other work, family, and individual well-being topics.

Learning Journeys also reinforced Dana's ongoing efforts to build higher levels of inclusion and diversity. Each quarter, a new course was introduced to assist people with further understanding of unconscious bias, blind spots, and collaborating effectively with different work styles to reach the higher levels of creativity that inclusion and diversity bring to our culture.

Connecting Through Diversity

During 2021, our diversity sourcing and recruitment programs had a strong impact as we continually increased our connectivity and exposure to new partners and organizations in the market.

Our efforts primarily focused on impacting key groups that we measure from a representation standpoint, namely women and minorities.

We remained committed to recruiting across other key communities and groups, such as the LGBTQ community.

We also increased our focus on military and veteran hiring by partnering with a third-party specialist to increase our access to this valuable demographic.

We continue to track progress against our interviewing policy, which requires gender and racial/ethnic diversity among external candidates at director-level and above in the United States.

Safety and Quality Trainings

As the pandemic evolved and essential workers started returning to the workplace, we created a course to detail the policies and procedures established to safely support our people.

This module was developed in multiple formats so that it could be deployed using varied delivery methods — to be played at a training kiosk, available online, or delivered in a group setting. We also made available a template that could be modified and translated to address specific requirements, policies, and procedures needed at the local level.

To support Dana's Quality Focused initiative, two trainings were created — one to provide an introduction and overview and the other to expand on Dana's Life Quality Rules — key elements that underpin the initiative. Each course was developed in two formats, one to be delivered online and another to be presented in a group setting at the local level. Both are translated into 20 languages.

The Respect in the Workplace module, part of the Operational Leadership training program, was made more interactive.

We incorporated facilitator notes and script so that it could be used by local leaders as a separate training program for all of the people in their facility, reinforcing Dana's expectation of a respectful and inclusive working environment.

Mentoring

Senior leaders around the world support Dana's commitment to accelerate our people's development by engaging in formal and informal mentoring partnerships.

Increasing confidence, broadening perspectives, expanding personal and professional networks, and identifying career paths count as some of the many benefits for Dana mentees.

Our focus on mentoring is also extended to our communities. For example, members of Dana's African American Resource Group volunteer as mentors for high-school and university students, as well as members of the National Society of Black Engineers.

Mentoring students helps to attract the best diverse talent and is also an opportunity for Dana mentors to develop and reinforce their leadership capabilities and give back to our communities.

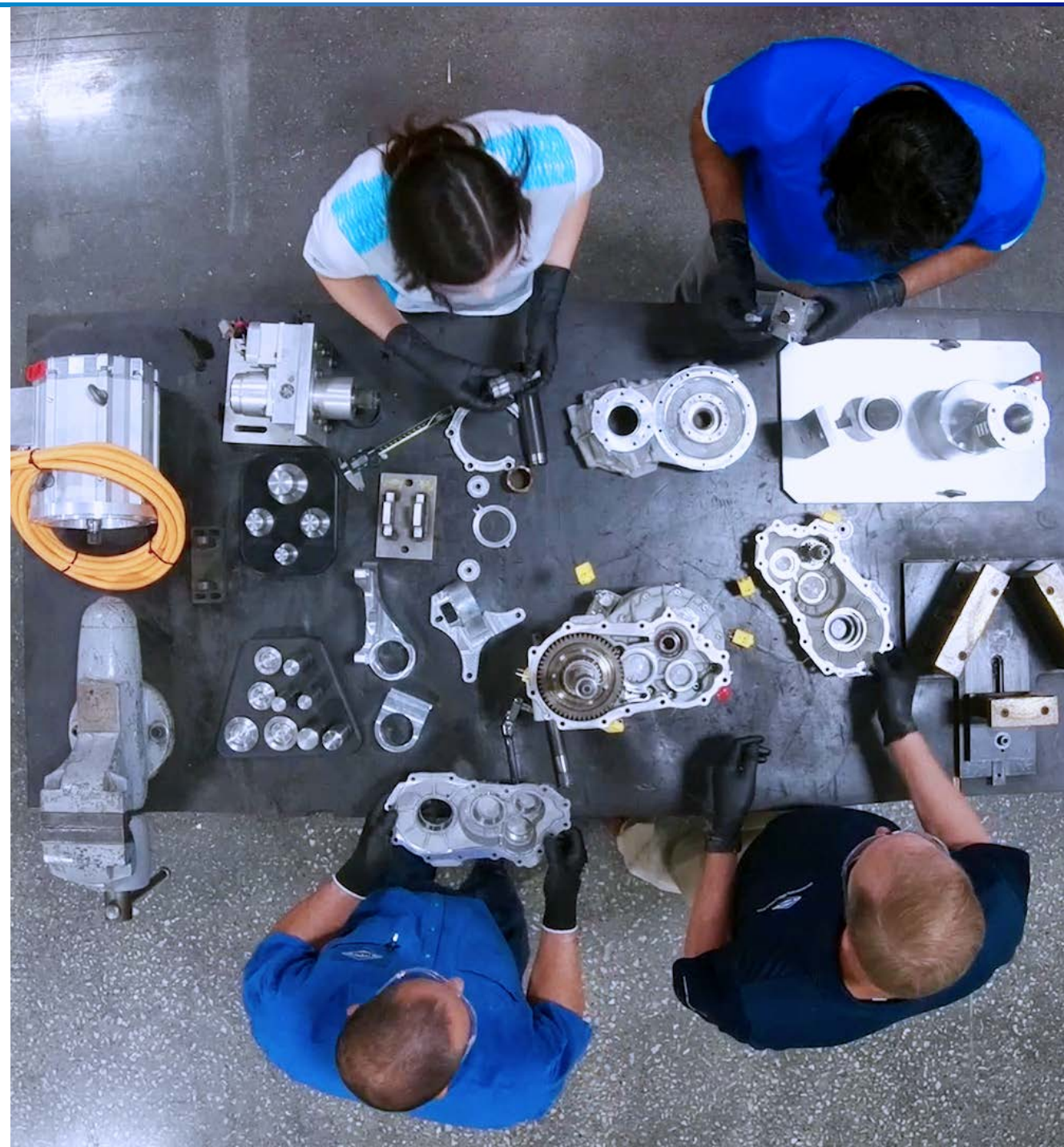

Andrea Kluc

Plant Manager Lead
Arco, Como, and Rovereto, Italy

At Dana, in Northern Italy, we are a technology-led assembly and manufacturing team for axles and gears — powering some of the biggest and most iconic vehicles and machines in the world.

Throughout my 16-year Dana career, we have always worked together to find a better way.

This means reducing energy consumption by deploying dry cutting machines, installing LED lighting, and using high-efficiency thermal power.

We also have very close ties with our communities.

I'm very proud of our work providing manufacturing machinery to local schools, sponsoring mechatronic awards at local institutes, and our time spent sharing Dana technologies and continuous improvement methodology at universities.

I truly feel a shared responsibility to build a better world and brighter future for the next generation.



The Importance of Health and Well-being

Health and well-being initiatives have long-lasting, sustainable impacts on an employee, including enhancing creativity, job satisfaction, and work-life balance.

For Dana, this means a more vibrant workforce, increased morale, talent retention, and a robust future for the company.

Dana believes in:

- the importance of striving for personal and work-life integration;
- a supportive work environment that cultivates the drive to succeed; and
- a willingness to explore new opportunities across the health and well-being spectrum.

We are committed to providing all employees with quality and competitive benefit programs that focus on all aspects of employee well-being, including physical, mental and financial. Our plans are benchmarked annually to ensure fit, competitiveness, and value.

Dana programs meet a wide range of needs and services related to the well-being of employees and their family. For example, many of our locations have retirement plans ranging from pensions to tax-deferred retirement savings plans.

Around the world, we provide financial wellness programs offering employees the opportunity to meet with financial counselors to help them learn about a variety of financial situations that may impact them — including budgeting, savings, and retirement planning.

The New Normal

As the pandemic continued in 2021, Dana remained resolute in the fight against Covid-19. We continued to enhance our pandemic-related protocols throughout our global operations as we gained a better understanding of the virus.

We ensured that our employees and their families had access to Covid testing and conducted on-site vaccine and booster clinics in many locations.

Additionally, we adjusted protocols — so that as there were spikes of the virus in certain countries — we increased the requisite precautions to ensure the safest work environments possible.

Employee Assistance Program

The impact of the pandemic on mental health has been a topic of concern for public health leaders, politicians, service providers, and care givers — and is something that we have prioritized for the benefit of our employees and their families.

In addition to Dana’s traditional Employee Assistance Program services, we provide further educational opportunities for employees to better understand ways to improve their mental health during and after these challenging times.

For example, our facilities in India created a quarterly Wellness Awareness session for employees and family members highlighting different topics to manage stress and cope through the lockdown. Additionally, they celebrated International Yoga Day with sessions to show their commitment towards holistic well-being.

In an effort to reduce any stigma around mental health issues, Dana facilities around the Toledo, Ohio, United States, area participated in an Out of the Darkness community walk. This was an

opportunity to discuss and acknowledge the ways in which mental health conditions have affected our lives and the lives of others in our communities.

At Dana, local mental health resources around the world are available to provide employees more information on where to find the support they may need.

Taking Action

The pandemic has been especially difficult for employees who are caring for their family — with changing school schedules and the risk of illness to themselves and their family.

In order to keep our employees engaged during these challenging times, our local teams have been innovative at creating employee events and experiences that include virtual options and also follow the Dana protocols for employee gatherings.

We felt the power of the Dana family, not just from the formal actions implemented across the organization to navigate the crisis, but also the individual behaviors that have made a significant impact on the safety and welfare of our people.

Together, we have worked to ensure that we remain safe and act responsibly whether on the job or in the communities that we call home.



Dana Communities

We are proud to contribute to and partner with organizations that are making a difference in our neighborhoods and believe that it is important for our communities to know who we are and what we are about.

We celebrate those teams and individuals who come together to build and nurture causes close to their heart and make a positive impact in the places where we do business and call home.

We believe that assisting our communities’ needs helps to build opportunities for people, and we continually provide outreach in many different forms.

These include supporting students in under-represented schools, donating food to local food banks, charity fundraising, cleaning roads and trails in local parks, and partnering with other organizations. Here are just a handful of examples of how our people around the world made a difference.



International Children's Day

International Children's Day is celebrated annually throughout the world.

In June 2021, Dana facilities in China commemorated the holiday by helping children in their local communities.

Dana TM4's China team held an artistic talent show where their children were asked to paint pictures centered around the theme: Energy Saving, Protecting the Environment, and New Energy.

In addition, the Dana team in Chongqing celebrated by volunteering to renovate a library for a rural primary school in the community.

Dana Walks in Support of Alzheimer's Awareness and Research

The Northwest Ohio, United States, chapter of the Alzheimer's Association held their annual Walk to End Alzheimer's — which is the world's largest event to raise awareness and funds for Alzheimer's care, support, and research.

Held in downtown Toledo, the Dana team helped to raise thousands of dollars with the highlight of the walk being the colorful Promise Garden where participants could dedicate a flower in honor or memory of a loved one.

The event was a huge success helping to raise awareness and money to fight a disease that affects so many people around the world.



Steffan Webb

Senior Gear Engineering Technician
Maumee, Ohio, United States

I work in global gear engineering at Dana laboratories located at our World Headquarters and the Advanced Manufacturing Center in Maumee, Ohio, United States.

This is a role that requires precision engineering and, above all, collaboration with teams around the world.

It's this spirit of togetherness that I think shapes how Dana people operate.

There is a duty of care for others. People here genuinely consider how their daily actions impact our planet — not only in what we design but in how we manufacture sustainably.

It's also in the interactions with our communities. I'm proud to join employee-led groups like Dana's Green Team working with the Toledo Metroparks to clean up trash on their trails and waterways, planting new trees, and holding electronic waste drive collections.

What we do as individuals matters. It adds up.



Dana Care Foundation: Advocacy in Action for India's Vulnerable Communities

In India, the Dana Care Foundation (DCF) helps the most vulnerable communities in society by advancing six social initiatives — namely education; vocational training; health and sanitation; rural upliftment; technology and R&D; and sustainability and disaster management.

Starting with a focus on education, DCF supports the Silver Lining Public School in Noida, educating 270 students all are from underprivileged backgrounds.

We also facilitate free midday meals and textbooks to all students and undertake similar work at two government schools at Sanand and Kolhapur by developing basic infrastructure and providing meals and uniforms.

Looking ahead, we sponsor higher education for 90 underprivileged students across Chennai, Hosur, Jodhalli, Manesar, Noida, and Satara regions — and deliver vocational training at Jodhali, Kolhapur, Noida, and Sanand to supporting the government's "Skill India Mission" initiative.

Making a Difference

To help make a difference where people live, we work to enhance basic infrastructure such as establishing primary healthcare centers; water



purification plants; and the construction of nurseries, primary schools, public libraries, and restrooms.

DCF is also actively involved in conserving the biodiversity of both rural and urban areas to promote clean air, water, and healthy soil. One of the major deliverables under this umbrella is the rejuvenation of ponds to promote and conserve ecosystems.

So far, we have deepened six ponds which has helped to enhance the fertility of the agricultural land in the region; raised the water level in the wells and thus the availability of clean, drinkable water; and improved irrigation for the five local villages near these projects.

As the pandemic continued throughout 2021, the Dana Care Foundation supported our communities by providing meals and dry rations, ventilators, medical beds, oxygen concentrators, as well as PPE kits and essential medicines.

Finally, to advance innovation through research and development and encourage a "start-up" ecosystem mentality in India, DCF partnered with leading universities such as the Indian Institute of Technology, the Indian Institute of Information Technology, the Vellore Institute of Technology, and the College Of Engineering Pune and Amity University providing financial support to 17 projects themed under corporate social responsibility.



Dana China Focus on Education

Dana Shanghai donated laptops to Fenshui Primary School, Luzhou City, China, as part of our efforts to support education in remote mountainous areas and villages.



Raising Funds for Children in Japan

In Japan, Dana participated in a charity cycle raising funds for the YouMeWe organization — helping children growing up in institutionalized homes in Japan. Participants cycled more than 350 miles from Takasaki to Fukushima over the course of four days.

In August, Dana partnered with Metroparks Toledo to advance the construction and maintenance of Glass City Metropark and Riverwalk in East Toledo, Ohio, United States. We also supported a new sustainability-focused lecture series and an ongoing Maumee River clean-up program.

Glass City Metropark Phase 2, currently under construction, is a significant portion of the more than \$200 million Glass City Riverwalk — a 300-acre greenway on the east and downtown sides of the Maumee River from the Anthony Wayne Bridge to the Veterans Glass City Skyway.

When complete, the space will connect six neighborhoods along both sides of the Maumee River.

Glass City Riverwalk is expected to become one of the region's most popular destinations, with year-round outdoor recreation opportunities, including adventure play areas and an ice-skating ribbon.

The series of projects will also enhance environmental quality through the beneficial reuse of brownfields and upgrades to the shoreline, which will improve the water quality of the Maumee River and Lake Erie.

This investment in Metroparks is an extension of our company's commitment to sustainability and social responsibility and will improve the environment and enrich the lives of people in the Toledo community for years to come.

Dana Partners with Metroparks Toledo To Create New Park and Lecture Series



One of the Longest Running LPGA Tournaments Now Called the Dana Open



One of the longest running and most popular stops on the Ladies Professional Golf Association (LPGA) tour will be known as the Dana Open presented by Marathon for 2022.

Dana's decision to be the title sponsor of this world-class LPGA tournament serves as a further example of our focus on inclusion and diversity and gives us the opportunity to support women who are role models and inspire others through their commitment to excellence.

The event has raised nearly \$13 million for children's charities in its 37-year history and will take place August 29 to September 4, 2022, at Highland Meadows Golf Club — about 15 minutes from Dana's World Headquarters, in Maumee, Ohio, United States.

Dana's Advances Vocational Education at Owens Community College

Officials at Owens Community College, Perrysburg, Ohio, United States, opened the new Dana Incorporated Advanced Manufacturing Training Center with a ribbon-cutting ceremony in October to celebrate the building project's completion and showcase the facility's new modernized features.

James Kamsickas, chairman and chief executive officer at Dana said the training facility is needed now more than ever as recent estimates project 2.4 million manufacturing jobs will go unfilled between now and 2028.

With the training center, he said Owens will now be a central hub where students can receive

cutting-edge training and have access to high-paying careers while area businesses will reap the benefits of an advanced workforce trained in their own backyard.

"This is an investment in the people who are critical to the work we do every day," he said. "It will also help with the development of skilled workers and bring people throughout the region to learn critical skills for both here, and northwest Ohio, and throughout the Midwest."

The 60,000-square-foot facility houses six skilled tech and training labs and allows Owens to offer skills, trade, and apprentice programs under one roof for the first time.



Acting **NOW** to protect our shared planet.



Leading by Example

Climate change is one of the most significant challenges of our time.

We lead by example, not only in the clean-energy technologies and products that we deliver, but also in how we operate our business — all with a focus on improving the environment.

We help build a better future for everyone we encounter and the planet that enables us to do our work.

Powering Innovation

We have navigated through more than a century of vehicle evolution and have helped to shape the electrification revolution for decades. Half of our new business backlog through 2024 comes from manufacturing next generation e-Propulsion systems and other clean-energy solutions.

We're proud to be the only supplier with the in-house capabilities necessary to deliver all the

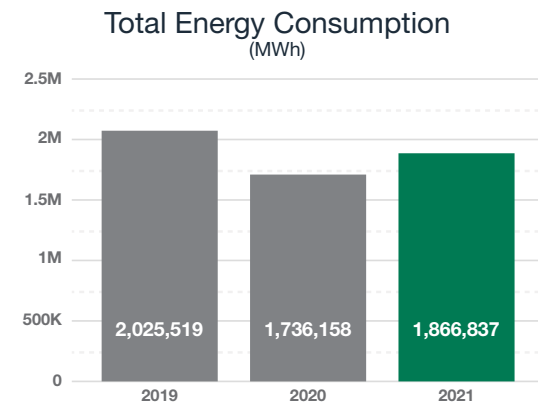
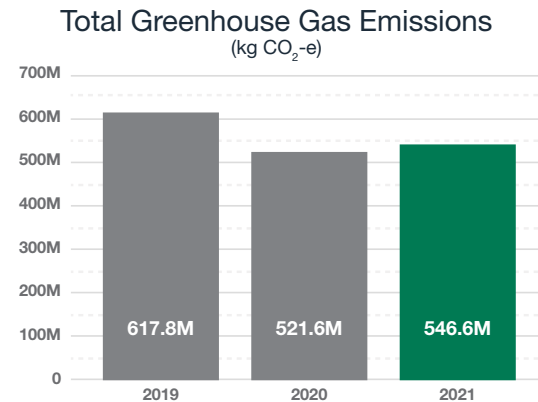



elements of a complete, fully integrated electrified system — across all mobility markets — anywhere in the world.

Being Better

We're reducing our global Scope 1 and 2 annual greenhouse gas (GHG) emissions by more than 50 percent by 2030.

How?

- By lowering our overall energy consumption.
- By driving efficiency improvements across our operations.
- By sourcing renewable energy from on-site solar arrays around the world.
- By entering into a renewable energy purchase agreement that will reduce 90 percent of our current United States annual electricity GHG emissions.
- By working collaboratively with our suppliers to drive sustainability improvements across our global supply chain.

Advancing Together

By delivering the clean-energy technologies powering vehicles and machines around the world, we are supporting our customers to achieve their sustainability priorities, while also reducing our global Scope 3 GHG emissions.

Driving Transparent, Verifiable Claims

We are committed to openly disclosing our ESG commitments and progress, and to being led by science-based methods. We are an industry leader, partnering with the world's foremost organizations to report on our climate impact actions.

By joining the Science Based Targets initiative and the Carbon Disclosure Project, we collaborate with others for the greater good and look forward to continuing our work with customers, suppliers, and others toward a sustainable future.

Supporting Our Vision

We have strategically invested and continue to invest to secure unparalleled technical competence in designing, engineering, and manufacturing the components of a complete e-Propulsion system in-house.

Expanded Use of Solar Arrays



Chakan, India



Jodalli, India



Pantnagar, India



Sanand, India



Toledo, Ohio, United States



Bari, Italy



Rivoli, Italy



Sommariva, Italy

Sustainability Award Winners

We work globally to champion sustainability across the organization.

Doug Liedberg, chief compliance and sustainability officer at Dana, announced our annual Sustainability Awards to spotlight some of the outstanding work from teams around the world and the significance of their impact on the environment.

Our **“Most Improved Facility”** went to Jodalli, India, in recognition of the team’s work to secure 88% of electricity consumed from solar energy.

Additional sustainability projects at Jodalli included planting 900 trees at the facility with a GHG reduction of approximately 13.5 metric tons per year in addition to rainwater harvesting with an expected 7,200 cubic meters of rainwater captured for use as ground water.

Our **“Best Initiative Award”** went to our facilities at Campinas and Jundiá, Brazil, for a waste composting project where leftover material from cafeterias is transformed into organic fertilizer. These facilities also recycled and sold steel shot to suppliers to be used as a raw material, with some 292 metric tons of steel shot recycled every year.

In 2021, we expanded the organic waste program to include three additional facilities from Dana’s Gravataí industrial complex. This composting initiative now prevents more than 320 tons per year ending up in the country’s landfills. The effort from these plants, where 3,000 Dana people work, helps to transform organic matter such as food waste, paper, and vegetation in a nutrient rich fertilizer as well as reducing soil pollution.

Our **“Most Innovative Initiative Award”** went to Dana’s Queretaro plant in Mexico where we optimized gas consumption from eight heat treatment furnaces. The eight optimized furnaces now account for 86% of the facility’s total natural gas consumption.

Use of an optimizer produces an electromagnetic field that changes the physical properties of natural gas to improve burn efficiency and facilitate heat transfer. This initiative has resulted in a reduction of 600 metric tons of GHG emissions.

Photos (top to bottom): Tree planting at Dana Jodalli, India; composting project at Dana Jundiá and Campinas, Brazil; optimizing gas consumption at Dana Querétaro, Mexico



India Team Recognized for Outstanding Environmental Practices

Dana's team in Noida, India, was recently awarded the prestigious Greentech Award for Environmental Protection.

Over the past year, the team planted approximately 10,000 plants and trees near the facility and successfully implemented a waste and water reduction project.

The award is presented annually in Chennai, India, and recognizes both private and public sectors that work to minimize their carbon footprint. Categories include corporate responsibility, safety, and environmental.



World HQ Composting Launch

The Dana Green Team launched a composting program at our world headquarters in Maumee, Ohio, United States. The goal of the program is to provide a more sustainable waste stream and reduce the volume of solid waste sent to landfills.

The initial composting program was focused on paper towel waste. In the six-month period (July – December 2021), we successfully recycled 4,880 lbs. or 2.21 metric tons of paper towel waste.

In 2022, we will continue to expand this program and implement across all the corporate campus facilities.

Dana's Ladkrabang, Thailand Driveshaft Facility Wins Four Awards

In late 2021, Dana's Ladkrabang, Thailand Driveshaft facility was honored with four awards centered around sustainability, operational excellence, and employee engagement.

In September, the team received the Green Industry Level 4 (Green Culture) Award from the Ministry of Industry, Department of Industrial Works. This award recognizes businesses that demonstrate a strong approach toward sustainability in their operations in addition to continuous improvements across their production process, environmental management, and social responsibility.



The team was also honored with the White Flag Green Star Award from the Industrial Estate Authority of Thailand for an environmental governance project promoting facilities operating in accordance with environmental and safety governance and recognizing excellence in social responsibility.

The facility also earned the 2021 Excellent Practices Establishment in Labor Relations and Welfare National Level – First Year of Achievement Award from the Ministry of Labor.

Lastly, they received the CSR-DIW AWARD 2021 from the Department of Industrial Works, Ministry of Industry.

The CSR-DIW standard was developed by the International Standards Organization and covers seven core subjects across corporate governance, human rights, labor practices, environment, fair operating practice, consumer issues, and community involvement and development.

Rolling Out Electric Forklifts in Brazil

In 2021, our operations in Sorocaba, Brazil, replaced Liquefied Petroleum Gas (LPG) powered forklifts with electric forklifts — securing a 38% reduction in the use of LPG-powered equipment.

The project was implemented in stages by analyzing and testing equipment, then leasing, and finally replacing the entire fleet. Management is currently exploring the use of solar energy to charge these new forklifts.

The success of this project has inspired our operations in Gravataí, Jundiaí, and Campinas to set a goal of replacing their entire fleet of LPG-powered vehicles.



Collecting Recyclable Packaging

Dana supports the Recupera Program in Brazil — a nationwide initiative that promotes reverse logistics for consumer product packaging in the Brazilian market, such as those used in the automotive aftermarket sector.

Our actions strengthen the social and productive inclusion of collectors of recyclable materials and recovered 105 tons of recyclable waste in 2021.

Dana expanded the project's scope to include all Brazilian states and the broad range of our products in the country's aftermarket sector.

The Recupera Program has already invested more than \$275,000 in 71 cooperatives and associations in Brazil, generating positive impacts on the lives of almost 1,500 people who collect recyclable waste in the country.

Dana Issues \$400 Million Green Bond

In April 2021, Dana announced a \$400M green bond to assist in supporting initiatives to lower our own carbon footprint as well as increasing investment in green and sustainable projects — thereby playing a key role in the transition to a low carbon economy.

The issuance of this green financing instrument will enable Dana to engage with those investors who are committed to supporting our sustainability efforts.

Examples of potential investments and expenditures include:

- The design, development, and manufacturing of products and systems which promote the electrification of vehicles including electric motors and inverters, electric vehicle systems, and e-Powertrain systems.
- Financing related to the acquisition, development, operation, and maintenance of equipment or systems that generate or transmit renewable energy.
- Financing related to investments in the construction of buildings and application of processes that are environmentally responsible and resource efficient throughout the building's life cycle.

Photo: Inverter assembly in Arzignano, Italy



Global Examples of Sustainability in Action

Chatham, Ontario, Canada

Focused on a facility-wide energy efficiency culture, shut off idle equipment, controlled facility heating and achieved 25% overall energy reduction.

Fort Wayne, Indiana, United States

Installed a water chiller on process equipment to phase out a non-contact water cooling process eliminating the consumption of 25,000 cubic meters of purchased water.

Toledo, Ohio, United States

Consumed renewable electricity provided by an adjacent solar power plant accounting for 3,300 MWh of renewable electricity consumed and 1,500 metric tons of greenhouse gas avoidance.

Jundiaí and Campinas, Brazil

Collected 70 metric tons of food scraps from facility cafeterias — sent off-site for composting and used as agricultural fertilizer. Recycled 292 metric tons of used shot blast material.

Sorocaba, Brazil

Replaced propane-powered forklifts and tugs with battery powered units. The gas elimination will reduce GHG emissions by 300 metric tons. Further investigating the process to charge the electric forklifts and tugs using dedicated solar power.

Dana Global

Reduced non-value consumption of electricity by hibernating idled equipment. Facilities that adopted this practice identified a reduction in electricity consumption of more than 7,000 MWh — avoiding some 3,000 metric tons GHG.

Dana North America

Implemented 21 compressed air system projects ranging from compressed air leak repair to installation of efficient compressed air systems delivering some 1,100 MWh of electricity savings and 550 MT of GHG reduction.

Paris, Tennessee, United States

Applied energy efficiency practices targeting LED lighting improvements and non-value electricity consumption by production equipment, compressed air loops, and water chiller loops. Targeted 600 MWh of electricity reduction and avoided 232 metric tons of GHG emissions.

Querétaro, Mexico

Initiated natural gas optimization technology on facility heat treat furnaces with an estimated reduction of 3,000 MWh and 600 metric tons of GHG reduction.

Global Examples of Sustainability in Action

Dana Europe

Commenced 17 projects related to lighting improvements including installation of new LED fixtures and automatic power switches for interior and exterior facility lighting. These projects will reduce 1,000 MWh of electricity consumption and 330 metric tons of GHG emissions.

Zaragoza, Spain

Improved a component mixture to eliminate material and resulting waste. The process improvement eliminated the need for a solvent cleaning machine and reduced 3,300 kgs of waste.

Giscard, France

Modified finished component packaging to eliminate corrugated plastic sheets. The new packaging removed the potential for five metric tons of plastic waste and opened storage space previously occupied by the plastic dunnage.

Rovereto, Italy

Altered wood pallets received from suppliers to meet Dana Italy pallet standards. The altered pallets are then used for facility shipping rather than being disposed of — the facility has targeted a reduction of 20 metric tons of wood waste per year.

Dana Global

Continuing to utilize generated and purchased renewable electricity throughout our operations and look to grow the 17,200 MWh of green electricity consumed.

Dana Asia Pacific

Identified 40 ideas for energy efficiency improvements related to facility lighting upgrades, manufacturing process improvements, and compressed air system repair and modifications. The projects target over 1,200 MWh of electricity consumption and 750 metric tons of GHG emissions.

Wuxi, China

Used air conditioners to replace water-cooled air conditioners for screen printing machines — resulting in a reduction of electricity consumption by 135,000 kWh. The facility also engaged in soundproofing to address noise pollution and lowered the amount of wastewater by 153,000 liters.

Chakan, India

Implemented water reduction/reuse programs to reduce 19,000 cubic meters of freshwater consumption. The programs included new water taps, controlled irrigation, and reuse of treated water for facility process and other non-process demands.

Jodalli, India

Installed rooftop solar panels and purchased renewable electricity for a total renewable electricity consumption of 6,169 MWh. The renewable electricity avoided 4,432 metric tons of GHG.

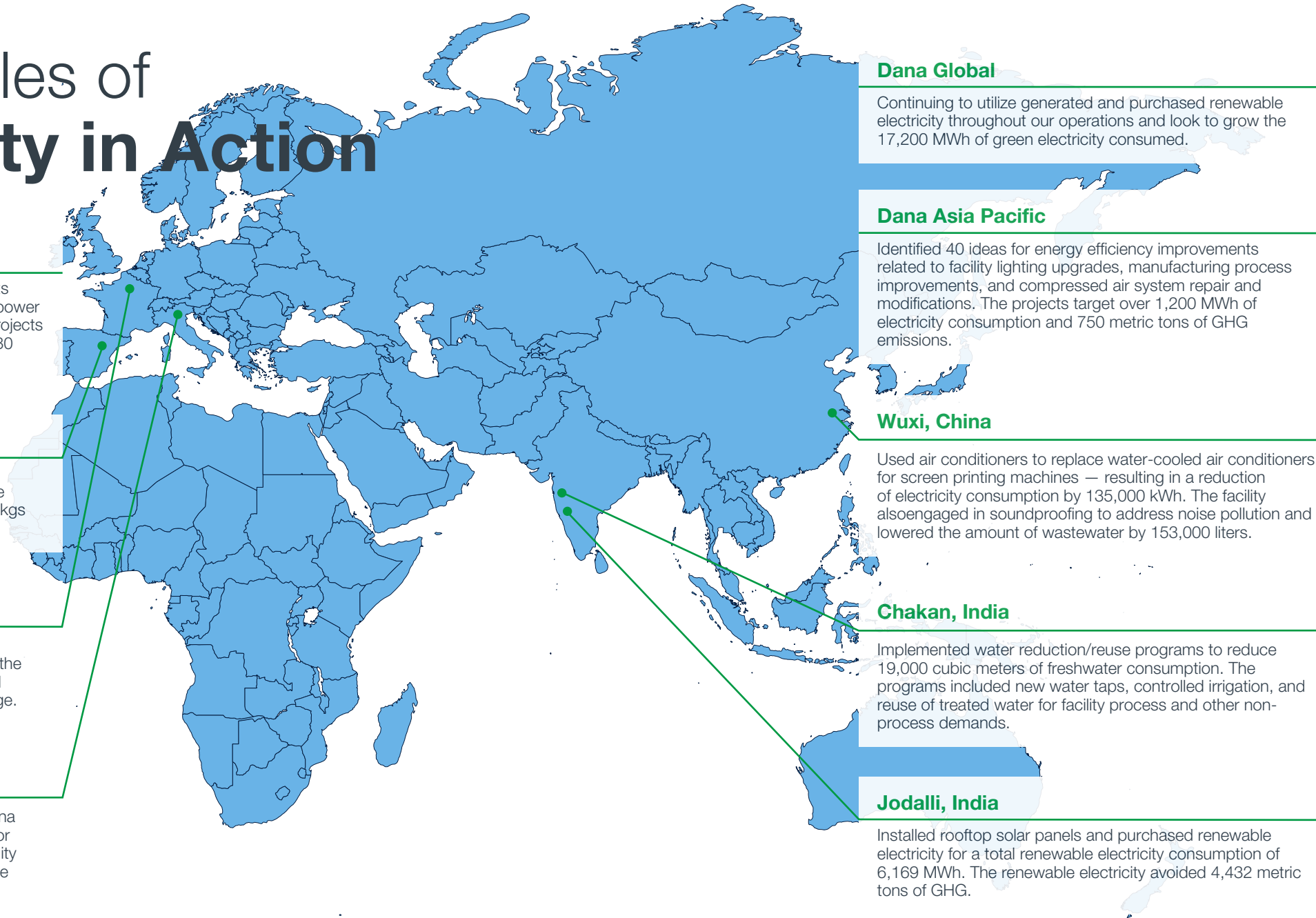

Our commitment to reduce greenhouse gas emissions



Scope 1

From Operations

Improving operational efficiencies and reducing on-site fuel consumption

(including natural gas, propane, diesel, gasoline)

Transitioning to electric vehicles

(including company vehicles, forklifts)

Installing on-site EV chargers

(including supporting transition to clean energy)

Improving building energy efficiency to reduce on-site fuel consumption

(including insulation, temperature automation, and capture / re-use of waste heat)

Sustainable Mobility Center



Scope 2

From Purchased Electricity

Continuing to lock-in operation efficiency improvements and reduce electricity consumption

(including equipment autohibernation, compressed air system efficiencies, energy-efficient HVAC systems, energy-efficient lighting)

Installing on-site renewable energy generation technologies

(including solar arrays, wind turbines)

Leveraging off-site wind and / or solar power generation via power purchase agreements

(including adding 300,000 MWh to the United States power grid)

Scope 3

From Other Indirect Emissions

Delivering new clean energy technologies and products

(including e-Propulsion systems, battery cooling, fuel cells, light-weighting, fuel efficiency)

Evaluating suppliers to drive improvements across supply chain

(including selection and monitoring process, performance scorecards)

Driving inbound and outbound transportation efficiencies

(including raw materials, components, and finished products)

Leveraging virtual communications tools to optimize travel

(including smart work practices reducing carbon footprint)



Reducing our carbon footprint. And yours.



Driving a World-Class Sustainable Supply Chain

A wide-angle photograph of a modern industrial manufacturing facility. The floor is highly reflective and clean. Several workers in blue shirts and khaki pants are engaged in various tasks. In the foreground, a worker is operating a large piece of machinery. In the background, other workers are visible near different pieces of equipment. The ceiling is high with a complex network of blue structural beams and overhead lighting. The overall atmosphere is one of a busy, organized industrial environment.

Dana has 139 major facilities strategically located across 31 countries on six continents.

We're committed to building a carbon-neutral supply chain and we work closely with suppliers to align their performance to meet our sustainability and social responsibility requirements — as reflected in our [Supplier Standards of Business Conduct](#).

Reach Your Goals

We know that our climate actions also impact your sustainability goals.

We therefore closely benchmark and monitor our supplier base to improve the sustainability performance across our supply chain — including the analysis of global Scope 3 GHG emissions.

We regularly score our suppliers based on several important attributes, including their ESG rating. We recognize that our performance, and the performance of our supply chain, is important to you and positively impacts your sustainability objectives.

By optimizing our supply chain, we reduce our carbon footprint — and yours.

Strategically Located Near You

Because we operate near our customers all around the world, our global footprint shortens outbound delivery times, reduces the need for shipping, and enhances supply chain security.

Our global team manages and tracks logistics across the entire supply chain. By optimizing our supply chain and the transportation required, we reduce our carbon footprint — and yours.

Setting Standards

The Chartered Institute of Procurement and Supply (CIPS) recently awarded Dana with a Certificate of Procurement Excellence.

This made us the first automotive company globally, and the first company in North America, to be recognized with the CIPS Procurement Excellence Award.

Every Decision Counts

We drive sustainability and social responsibility as a key part of every purchasing decision. Our systematic and integrated approach empowers suppliers to be engaged. This includes our detailed evaluation process analyzing key considerations

such as quality, total cost of ownership, ESG, inclusion and diversity, and risk mitigation.

Investing in Our People

As part of our *People Finding A Better Way* culture, we are always focused on continuous improvement and talent development to ensure that our global purchasing team leverages best practices.

Policy Action

As a company with global operations, we support the sourcing of raw materials and components responsibly. Respect for basic human rights and dignity is a fundamental part of our culture. We commit to carrying out business responsibly, sustainably, and ethically.

What's in a Number?

2,913 ... the number of production suppliers in more than 50 countries shipping to 139 major Dana facilities.

98% ... the percentage of Dana strategic suppliers responding to a 2021 survey indicating that they had policies addressing each of six key areas — health and safety, human rights, employee diversity, sustainability, code of conduct, and information security.

Steve Slesinski

Director, Global Product Planning
Maumee, Ohio, United States

The electrification of clean, affordable, accessible, safe, and efficient ways to move our world is what motivates me every day.

I have been with Dana well over 40 years now and have seen how we repositioned the business to support our customers' clean-energy priorities in every mobility market.

How we design and manufacture at scale to advance their e-Mobility journey.

How we leverage co-innovation and individual contributions to make a real difference.

So, it's working with hundreds of leading engineers, technicians, and scientists to help tackle climate change.

These electrification components and systems — electric motors, inverters, chargers and converters, and software and controls — have a hugely positive real-world impact. I'm just proud to be part of it all.





Dana Jumps 91 Spots on Drucker Institute's List of America's Best Managed Companies

Each year, the Drucker Institute evaluates corporate performance and effectiveness based on five core dimensions — customer satisfaction, employee engagement and development, innovation, social responsibility, and financial strength.

Effectiveness is defined by Drucker as “doing the right things well.” For 2021, Dana ranked 355 out of the Top 846 companies that Drucker evaluated based on their market capitalization and revenue.

This is up 91 spots from our 2020 ranking, largely driven by a continued commitment to sustainability and social responsibility and customer satisfaction.

Dana's Sustainability Supplier of the Year

We gave our Sustainability Supplier Award 2021 to the Brazil operations of multinational steel manufacturing corporation ArcelorMittal — an organization committed to reaching net-zero on a global basis by 2050.

They worked with the Brazilian government to advance the use of existing sustainable bioenergy — ensuring the clean energy critical to accelerate the decarbonization of the steel industry.

They also adopted an ambitious set of carbon targets, focused on innovation, and invested heavily in response to the global pandemic.

Dana's Diverse Supplier of the Year

We awarded our 2021 Diverse Supplier of the Year Award to SIM Inc. of Toronto, Canada. SIM Inc. has been a supplier of precision machined parts to Dana for over five decades, and during that time our collaboration has grown significantly.

During 2021, they expanded their production into additional new product areas to support Dana's needs. The partnership is a testament to our diversity program and the willingness of our partner suppliers to support Dana and their local communities.



Dana's Supplier Diversity Team Honored by Great Lakes Women's Business Council

In September 2021, Dana was presented with the Great Lakes Women's Business Council Excellence in Supplier Diversity Award for 2020.

This award is based on Dana's overall supplier diversity purchasing performance metrics — an honor demonstrating Dana's commitment to inclusion and diversity at every level of the business.

The “Advanced” category is an indication that a corporation has an increasing commitment to woman business enterprise contracting opportunities and capacity building.

The Great Lakes Women's Business Council helps to empower women and minorities economically through access to capital assistance programs, business development training, vendor certification, and business-to-business networking.

Every Decision Counts

Dana's Purchasing Decision Matrix

Total Cost of Ownership

- Cost
- Working Capital
- Tariffs and Duties
- Logistics

ESG

- Environmental
- Human Rights
- Safety
- Security
- Governance
- Compliance

Inclusion and Diversity

- Women Owned
- Minority Owned
- Veteran Owned
- LGBTQ Owned
- Other Owned

Quality

- Delivery
- Parts per Million Defective

Collaboration

- Transparency
- Agility
- Technology

Risk

- Performance
- Financial
- Geopolitical
- Reputation



Changing **our world** through e-Propulsion.



Dana Has a Guiding Vision Toward a Zero-emissions Future

It's at the heart of everything we do and why we have been supporting our customers' e-Propulsion journey for decades.

We are able to serve our customers with a full range of products — from individual solutions to fully integrated systems. And we are uniquely positioned to provide that support across all mobility markets.

Tomorrow's world, today

Half of our new business backlog through 2024 comes from innovating next generation clean-energy technologies and products.

This means pioneering efficient electric-vehicle systems, shaping market trends, and fast-tracking new electrodynamic products like motors, inverters, controls and software, chargers, e-Power cradles, battery cooling systems, and bipolar fuel-cell plates.

All mobility markets. Everywhere

We're proud to be the only supplier with the in-house capabilities necessary to deliver all the elements of a complete, fully integrated electrified

system — across all mobility markets — anywhere in the world.

The art of the possible

Our global technology centers are strategically located in nine countries where we co-innovate near our customers. They're home to more than 2,300 of the world's leading engineers, technicians, and scientists developing new products and breakthrough advances in e-Propulsion.

Exploring beyond

It's not just electrification. We're delivering technologies and products for all of tomorrow's power sources, such as thermal-management solutions for batteries, power electronics and insulated-gate bipolar transistors, e-Motors, and engines.

Our innovations have helped to eliminate traditional costs and performance barriers — a crucial step for the adoption of fuel-cells.

We are also advancing active and passive system controls and descriptive and predictive analytics.



Dana's Work on OX Electric Truck Showcased at COP26



The 26th UN Climate Change Conference of the Parties (COP26) took place in Glasgow, United Kingdom, in November 2021.

Dana's work on the OX Delivers truck e-Powertrain — the world's first flat-pack utility vehicle destined for emerging markets in Africa — was spotlighted internationally at COP26 on Transport Day.

The truck is powered by Dana's Spicer Electrified™ eS4500i e-Drive Unit, which combines an electric motor, inverter, gearbox, and software in a complete e-propulsion system.

Transitioning emerging markets to electric transport is a huge opportunity to deliver COP26 climate targets and progress towards the UN Sustainable Development Goals.

With their low operating costs electric vehicles make sense for low-income economies, home to 15% of the global population.

Dana Establishes New Electrodynamic Facility in Sweden

The Dana TM4 joint venture began work on a new electric motor manufacturing facility in Åmål, Sweden.

The \$50 million fully sustainable operation further boosts Dana's ability to deliver clean energy technologies and fully integrated e-Propulsion systems across all mobility markets.

Supported by a robust supply chain and highly automated manufacturing methods, the facility is expected to open in late 2022 and will produce a range of Dana TM4 MOTIVE™ high-speed electric motors for vehicles that will begin production in the first half of 2023.

This new facility received \$10.7 million in support from the Swedish business development community and will be the company's largest electrodynamic facility in Europe.



Robert Boffey

Plant Manager
Åmål, Sweden

Sweden is a very special place for Dana. It's a remarkable country where we have been present for more than 100 years — powering vehicles and machines around the world.

We know that mainstream electric vehicles will transform the automotive industry and help to decarbonize the planet.

Our new electrodynamic facility in Åmål will play a small, but important, role in this evolution.

Right here from Sweden, we'll be delivering clean-energy technologies and fully integrated e-Propulsion systems across all end-markets.

I'm so proud to be part of the Dana family and know that we have a guiding vision toward a zero-emissions future.

It's at the heart of everything we do, and why we focus on our electrification pursuits.

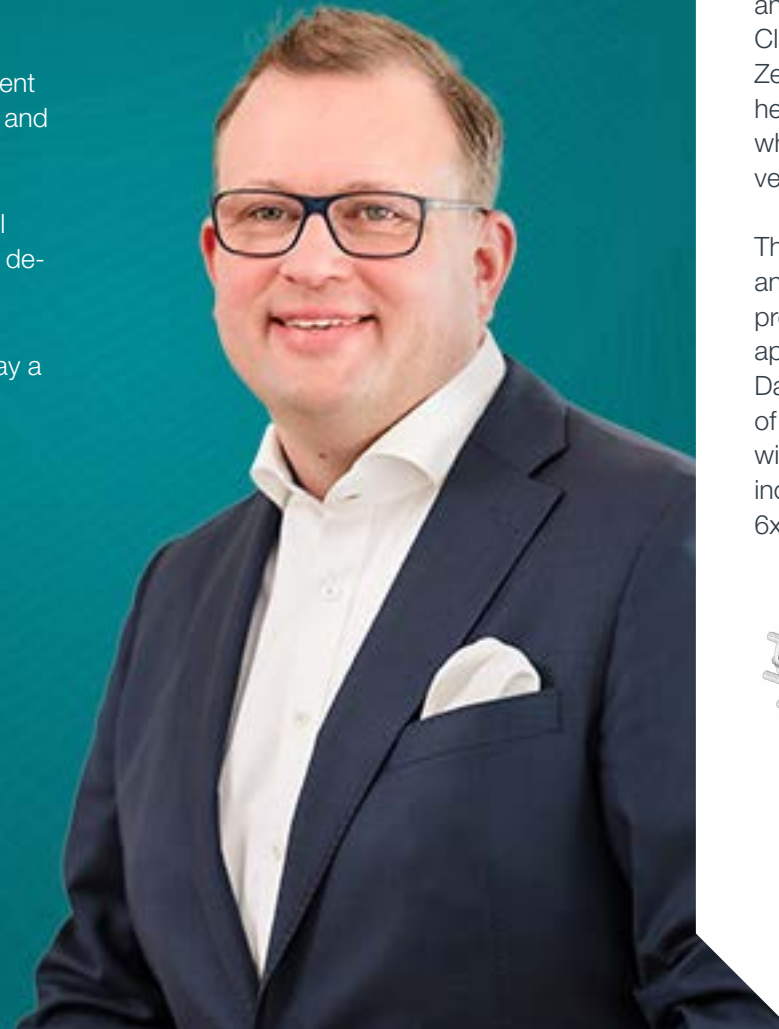

New e-Axles to Power Class 7 and 8 Vehicles

Dana expanded its Spicer Electrified™ e-Powertrain offerings to include a family of single and tandem e-Axles designed for a wide variety of Class 7 and 8 applications. The Spicer Electrified Zero-8 e-Axles complement Dana's established heavy-duty electric-vehicle e-Propulsion systems, which are currently powering thousands of vehicles around the world.

The Zero-8 e-Axles leverage Dana's most robust and efficient drive axle technology and are precisely engineered for demanding, over-the-road applications. The new e-Axle portfolio supports Dana's approach to meet the diverse landscape of Class 7 and 8 electric vehicle architectures with multi-faceted electric powertrain solutions, including systems for direct drive, 4x2, 6x2, and 6x4 multi-speed e-Axle systems.

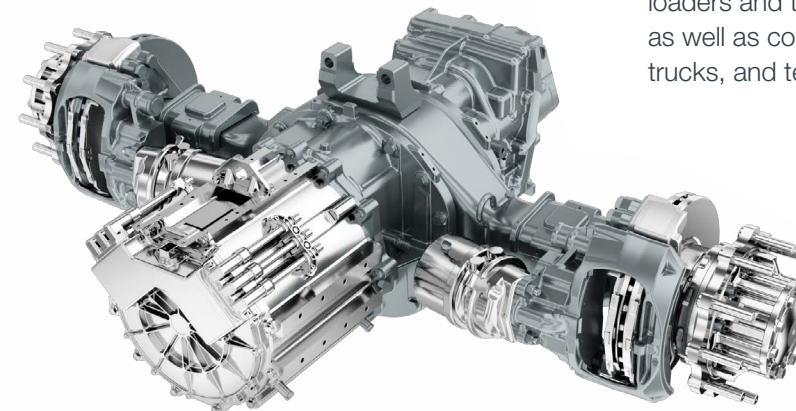

New e-Powershift Transmission Accelerates Electrification of Underground Mining Vehicles

Dana debuted its new Spicer Electrified™ e-Powershift transmission, a modular and flexible wo-speed solution that offers power take-off functionality for electrified heavy-duty mining vehicles.

Delivering high efficiency and superior performance in a compact package that simplifies the mining industry's transition to electrification, the dual-motor version of the e-Powershift transmission supports continuous power outputs up to 322 horsepower (240 kW), while the single-motor configuration is engineered for 161 horsepower (120 kW) of continuous output.

Its flexible, power-dense design makes the transmission ideal for small- to medium-sized loaders and trucks used in underground mining, as well as construction wheel loaders, large lift trucks, and terminal tractors.

Dana Commercializes Metallic Bipolar Plates for Fuel-cell Stacks

Dana signed a long-term cooperation agreement with Robert Bosch GmbH to mass produce metallic bipolar plates for fuel-cell stacks. Dana's licensed intellectual property will serve as the foundation for the companies to co-develop and co-produce the next generation of metallic bipolar plates and drive excellence across manufacturing processes.

Dana's metallic bipolar plates are an integral component in the fuel-cell stack and deliver improved cost, performance, and seamless assembly, aiding OEMs in realizing

commercialization of fuel-cell powered mobility. Bosch's overall fuel-cell stack system know-how and strong process competence in mass production will enable both companies to further increase cost competitiveness and performance, and successfully launch the serial production of bipolar plates.

The plates are expected to support fuel-cell powertrains for commercial-vehicle applications in Europe, Asia Pacific, and North America beginning in 2022.



Spicer Electrified™ e-Powertrain Earns Two Awards at 2021 Diesel Progress Summit

Dana earned the New Power Technology Award and the Achievement of the Year Award for its Spicer Electrified™ e-Powertrain at the 2021 Diesel Progress Summit and Awards. The awards recognize Dana's ability to provide a complete, fully integrated e-Powertrain to customers.

The Diesel Progress Summit Awards honor commercially available powertrains, with a focus on the dramatic changes that are being driven by emission regulations and advances in hybridization, electrification, and other technologies.

The New Power Technology Award specifically honors a supplier that has developed a component or technology in support of non-diesel applications, while the Achievement of the Year Award is given to the "best of the best" among the 2021 award winners, further setting Dana apart.

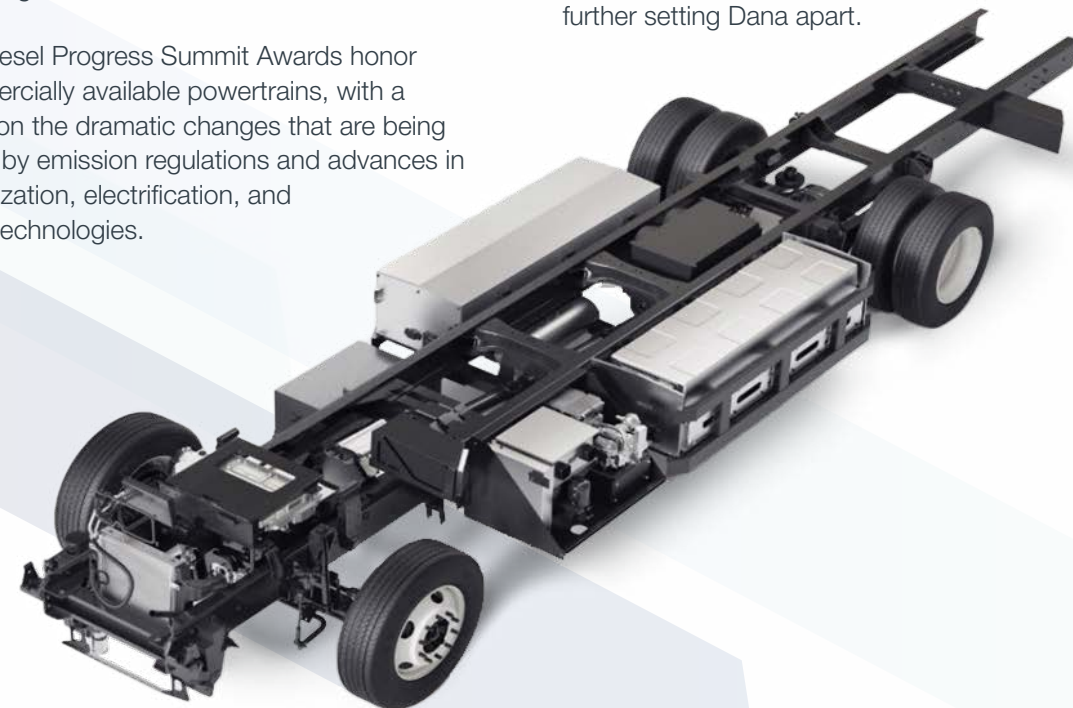



Dana and Switch Mobility Partner on Electrified Commercial Vehicles

Dana signed a strategic agreement with Switch Mobility Ltd., the electrified commercial vehicles company and subsidiary of Ashok Leyland Ltd, a leading commercial-vehicle manufacturer.

As part of this strategic investment, Dana became a preferred supplier of electric drivetrain components for Switch Mobility's electric bus and commercial vehicle offerings, providing e-Axles, gearboxes, motors, inverters, software and controls, and electronics cooling.

Dana Unveils New Motor and Inverter Series

Dana launched an expanded family of Dana TM4 SUMO™ HP electric motors and inverters, including the HV1000 and HV2500. The Dana TM4 SUMO family is specifically designed for battery-electric, range-extended, and fuel-cell vehicles.

These high-performance motors and inverters are engineered to offer maximum flexibility, enabling direct-drive, series-hybrid, or parallel-hybrid applications. The technologies are currently in production.

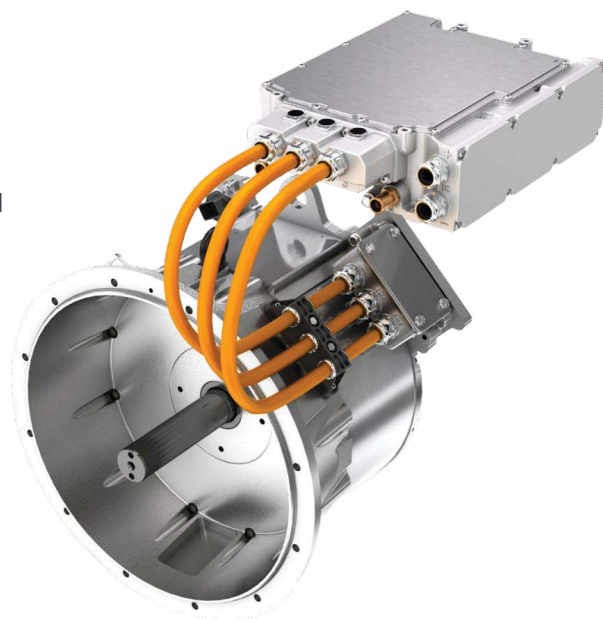

Idris A. Poonawala

Senior Manager, Off-Highway Product Engineering
Pune, India

As far back as I can remember, I've always had a passion to solve, to discover how the world around me worked.

It's the very same drive that led me to a career in engineering, to learn about new technologies and bring to life the very first lines that we draw at concept and design.

At Dana, I believe that we truly are "Powering Innovation To Move Our World."

It's an approach that shapes my work designing innovative electrical drive systems and modular technologies being adapted across multiple axle types.

What strikes me most at Dana is our focus on a sustainable future.

For me, this comes from a sustained investment in our people and the technologies that advance our customers' electrification journeys.





Hydrogen Heavy-duty Trucks Equipped with Dana TM4® in China

In 2021, 60 hydrogen fuel high-end V9 and mid-to-high-end N8V platform heavy-truck trucks produced by Dayun Auto were equipped with Dana TM4 Sumo™ MD series motors and inverters.

The maximum output of the drive motor can reach 225 KW, providing a steady stream of power resulting in an ultra-long driving range.

The innovation used in these zero-emissions trucks also helped the Xiong'an area win the "Blue Sky Protection" accolade — a key component of China's air pollution action plan.

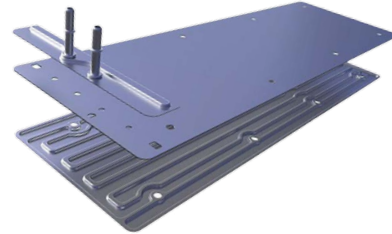

Ford Selects Long® Battery Cooling Plates for Its Electric F-150® Lightning®

Dana has been selected by Ford to supply state-of-the-art battery cooling plates to support the all-new F-150 Lightning truck's liquid-cooled, lithium-ion battery packs. Dana is honored to make an important contribution to this iconic vehicle.

Hyster-Yale Electric Terminal Tractor to Feature Spicer Electrified™ e-Transmission

Hyster-Yale has chosen Dana to supply an e-Transmission in support of its new electric terminal tractor. Dana's eSP502 transmission comes in a single or dual motor design and delivers high efficiency and superior performance in a compact package that will further enable the rapid transition to electrification.

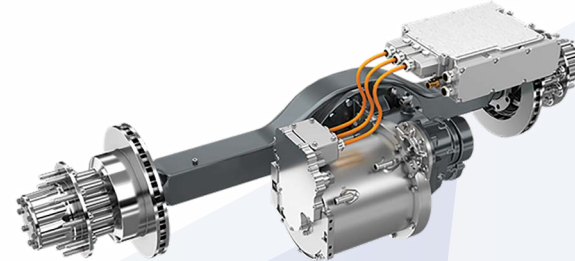

e-Axle Production Launched for Freightliner Custom Chassis Corporation

Dana will begin production of its Spicer Electrified™ Zero-6 e-Axles to support the market launch of the Freightliner Custom Chassis Corporation all-electric MT50e medium-duty last-mile delivery vehicle.

Designed with a custom Spicer® S130 rear drive axle, the propulsion system is engineered as a fully integrated e-Axle, including a gearbox and motor, providing up to 240 kW of power to support the vehicle's driving range of up to 170 miles.





Dana's New Sustainable Mobility Center Awarded LEED Certification

We received Leadership in Energy and Environmental Design (LEED) certification for our Sustainable Mobility Center at Dana's World Headquarters campus in Maumee, Ohio, United States.

LEED certification incorporates verified use of sustainable solutions as part of the facility's design, construction, and ongoing energy mix.

This comprises high efficiency lighting and temperature control equipment to help reduce overall consumption, lowering water usage, designated spaces for electric vehicles, and the establishment of a green maintenance program.

We believe that leading the way in sustainability is critical to supporting our customers and directly aligns with Dana's leadership in electrification. The center will play an important role in securing

our commitment to reduce our global annual greenhouse gas emissions by more than 50 percent by the end of 2030.

This state-of-the-art facility opened in August 2021 and focuses on the development of electrified products for each of Dana's end-markets, including motors for our e-Propulsion systems.

The Sustainable Mobility Center also offers a dynamic customer-experience center, showcasing Dana's electrified mobility technologies and systems engineering — while providing a location to educate and generate awareness around future mobility and all aspects of alternative propulsion powertrains.



**Yes to
science-
based
targets.**

Science Drives Our Strategic Approach to Sustainability

We know that it's crucial to transparently measure, validate, and report on our climate commitments.

It demonstrates that we are serious about the actions that we are taking to help improve the environment.

How You Measure Matters

We will remain an industry leader by joining the Science Based Target initiative (SBTi), a global “gold standard” organization, validating ambitious, science-based emissions reduction targets.



SCIENCE
BASED
TARGETS

DRIVING AMBITIOUS CORPORATE CLIMATE ACTION

We are proud to partner with SBTi's member organizations — Carbon Disclosure Project, United Nations Global Compact, World Resources Institute, and Worldwide Fund for Nature — to drive sustainable best practices and lead the way to a zero-carbon economy.

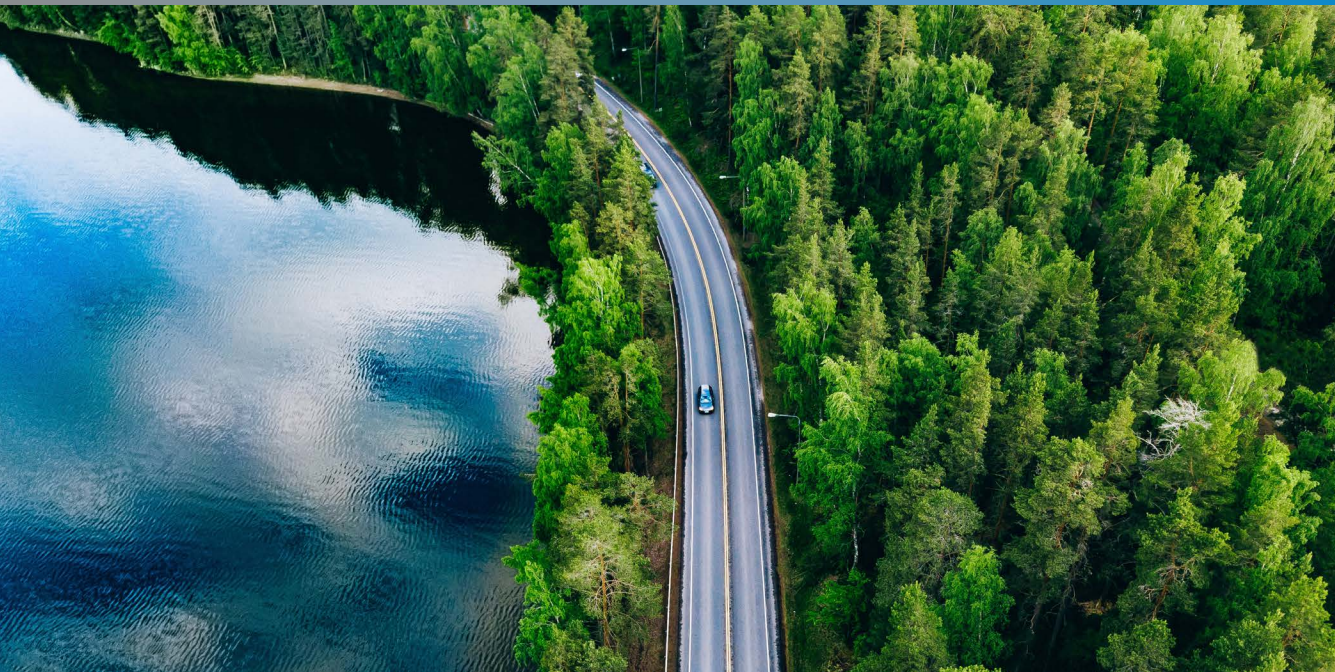

Carbon Disclosure Project

We report annually to the Carbon Disclosure Project (CDP), a global platform working with organizations of all types to drive positive environmental changes.

We are proud to support CDP's important mission to collect, measure, and reduce global GHG emissions.

Continuous Improvement

We leverage our robust environmental management systems to drive continuous improvement across the organization including initiatives to reduce water, energy consumption, waste, and emissions.

We also reuse and recycle to minimize our environmental footprint. These measures are part of our overall approach to regularly assess Dana's environmental compliance to ensure that we always operate to industry-leading standards.

Stephanie Roy

Sustainability Specialist

Novi, Michigan, United States

I believe that this decade will define the global response to the threat of climate change and that there is a moral case for action — to do the right thing.

I'm proud of Dana's leadership position on sustainability issues where we've made brave decisions based on principles, to inspire our company to succeed in the right way.

This has meant partnering with the world's foremost organizations to validate our climate commitments such as the Science Based Target initiative and the Carbon Disclosure Project.

It has involved a balanced approach that informs how we interact with our communities and advance electrification and hybridization technologies.

Regardless of where Dana's 40,000 colleagues live, we all have one home. Each day presents a new opportunity to "do good" for our people, our customers, and our planet.



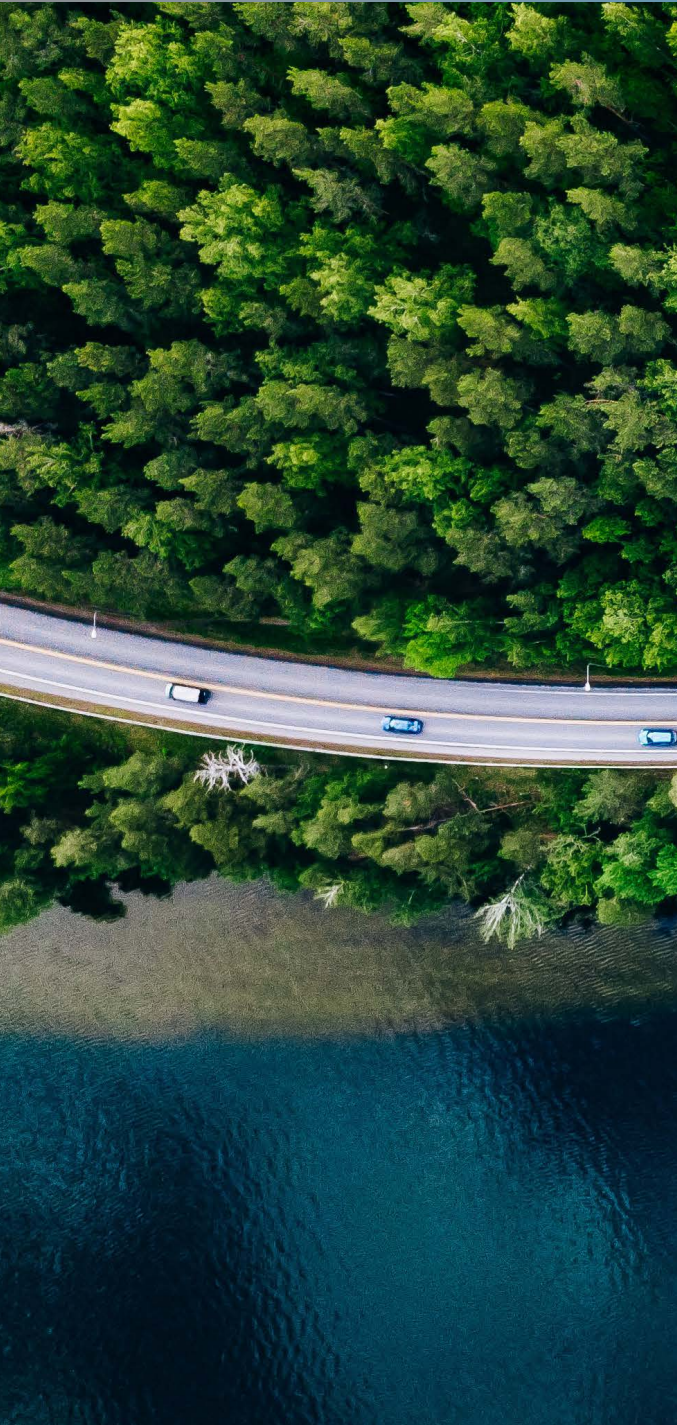

90th Percentile: Automotive Sustainability Leaders

We are proud to place in the 90th percentile for the automotive sector on the S&P Global Corporate Sustainability Assessment.

We also received the S&P Global 2022 Sustainability Yearbook Member Award — honoring top performing companies creating a stronger and healthier future for our planet.

Sustainability Yearbook Member 2022

S&P Global

Global Reporting Standards

Consistent with our commitment to disclose Dana's sustainability and social responsibility performance, we comply with leading global reporting standards including: the Global Reporting Initiative (GRI), the Sustainable Accounting Standards Board (SASB), and the Task Force on Climate-related Financial Disclosures (TCFD).

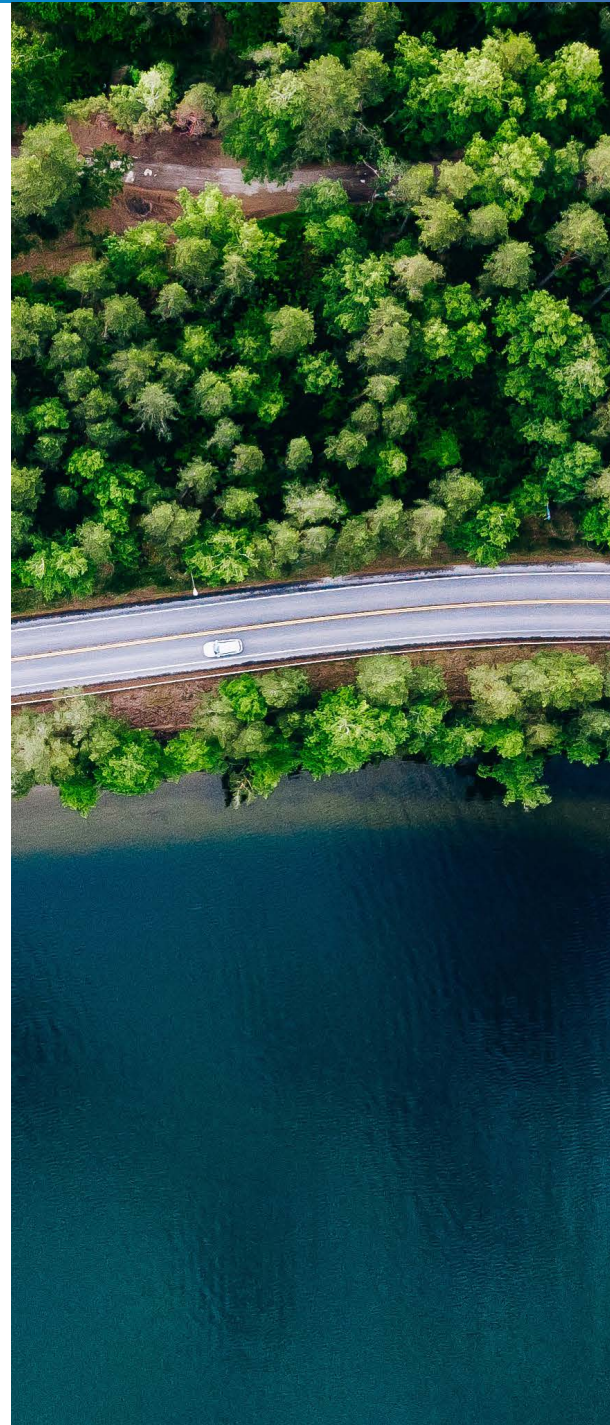

Holistic Approach to Sustainability Earns Industry Recognition

Dana received the inaugural Sustainability Award in Automotive from the ATZ/MTZ Group and Roland Berger for its Holistic Sustainability Approach.

The award recognizes companies with developed mobility solutions that take the environment and resources into account in a future-oriented and sustainable manner. It focuses on products, processes, and initiatives that have a holistic impact on sustainability in the automotive industry. Dana was selected from more than 50 submissions and was among eight winners in seven categories.

The judges specifically highlighted Dana's electric motor technology as a key factor for its selection, along with the company's strong commitment to environmental, social, and corporate governance.



Innovation. Here for it.

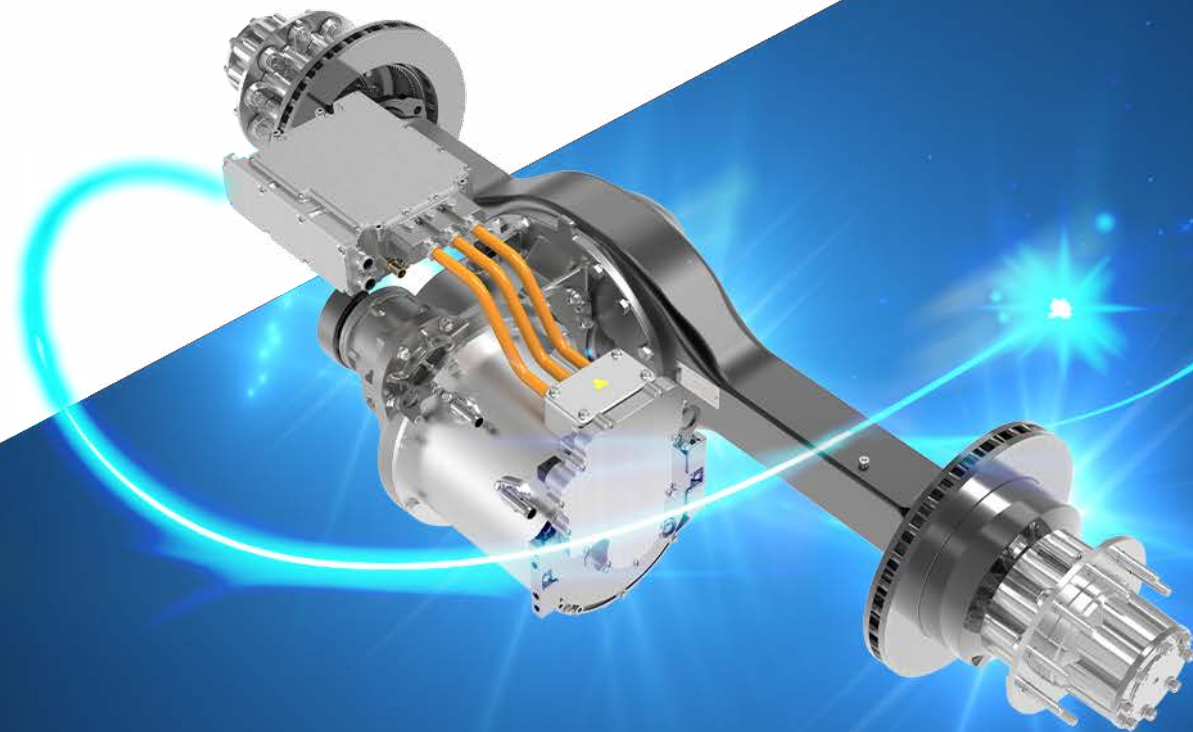

As a technology company, we partner with those who think without limits to advance novel, industry-shaping ideas. From metallurgy to physics, and everything in between, we optimize every aspect of what we do. That's why we've been around for well over a century.

Core Competencies

A diverse competency portfolio of shared expertise is employed powerfully across Dana, including disciplines from different scientific specializations such as mechanical engineering, acoustic and vibration, mechatronics, software development, cybersecurity, and systems engineering.

This involves experimenting and innovating relentlessly — working together with customers and academia to leverage new technologies, methodologies, and business models.

Global Awards

Dana technologies have won the Automotive News PACE Awards five times and been named as finalists on 19 occasions — recognizing our pipeline of innovative driveline, sealing, thermal, and digital solutions.

The Automotive News Premier Automotive Suppliers' Contribution to Excellence (PACE) Awards is known around the world as the industry benchmark for automotive innovation. They honor international automotive suppliers that bring game-changing innovations to their OEM customers and the automotive industry.

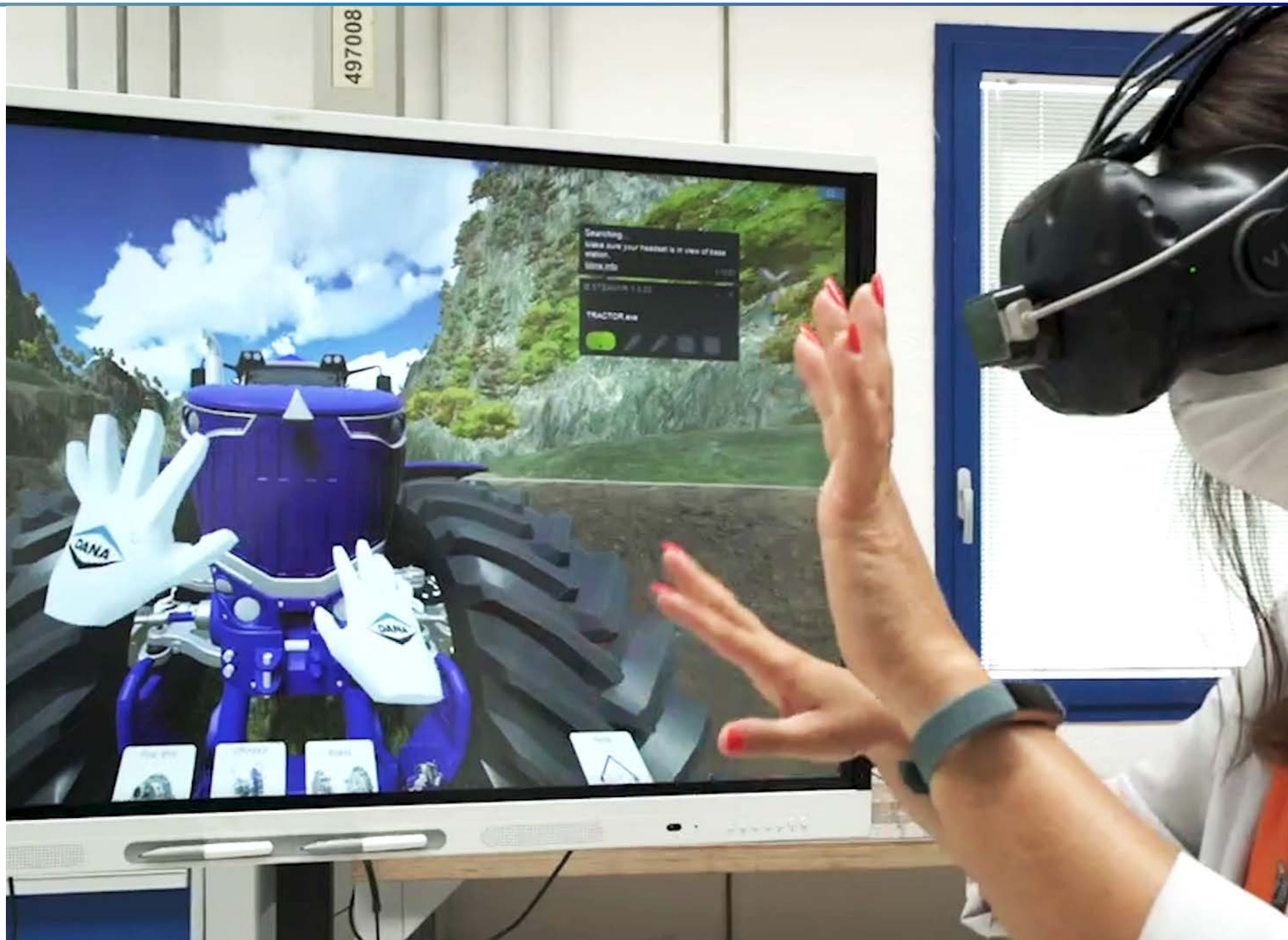

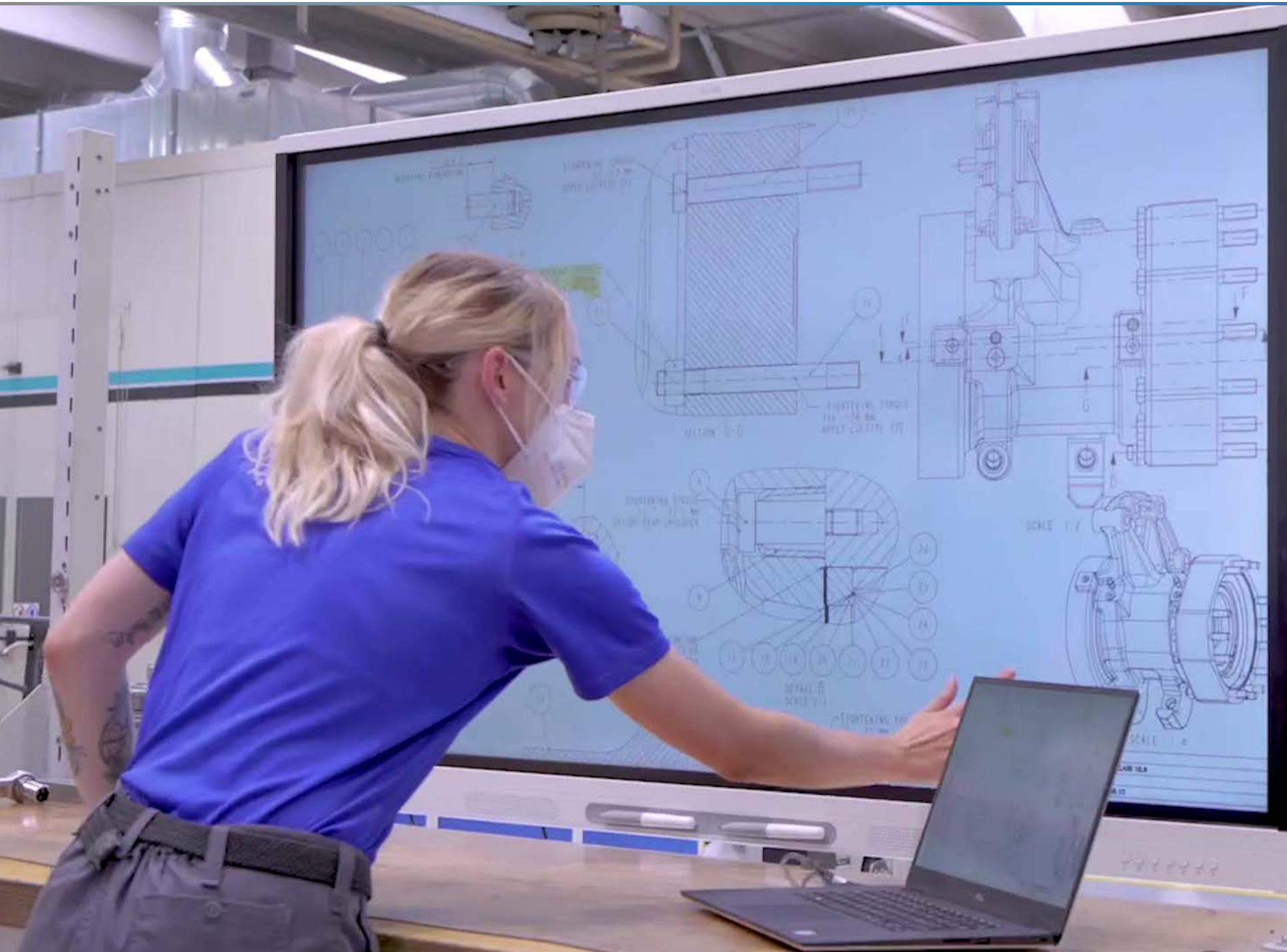

We have also been presented with an FCH Award— the Fuel Cells and Hydrogen Joint Undertaking — for our metallic bipolar plates for fuel cell stacks.

We also received an Automotive Innovation Technology Award in addition to recognition as an Outstanding Power Electronics Solution Provider for our insulated-gate bipolar transistors.

40,000 Strong

Our global team — diverse in make-up and broad in perspective — draws on international expertise and in-depth insight across market segments. Dana's culture is centered around collaborative innovation, helping to maximize sharing opportunities and teamwork.

Our integrated approach connects diverse global proficiencies with local perspectives, delivering elegant, high-value solutions and new product optimization across all end-markets.

Next-generation technologies

As a global leader in drivetrain and e-Propulsion systems, we use proving grounds around the world to test proof-of-concept systems as well as mature products for refinement and demonstration.

These allow us to validate next-generation technologies in the harshest environments and offer customers a first-hand experience of how Dana is powering innovation to move our world.

Global Technology Centers

Dana's global network of 23 technology centers across 9 countries allow us to innovate near and with our customers.

Dedicated to the pursuit of new ideas, products, and services — they are home to more than 2,300 of the world's leading engineers, technicians, and scientists developing breakthrough advances in next generation clean-energy technologies and sustainable products.

We collaborate to drive diversity, push new boundaries, and deliver on-the-ground, local solutions for customers as they continue to accelerate their electric vehicle portfolio development.

In fact, Dana's journey into electrification has been decades in the making. Along the way, agile development became a big part of our story helping us to create alignment between business planning and IT execution, deliver value faster, foster innovation, and de-risk solution delivery.

We also recognize the importance of strong relationships with our academic partners.

Our global network of universities throughout the Americas, Europe, and Asia provides a path for research and development, professional development education, and career opportunities transforming the future of mobility.

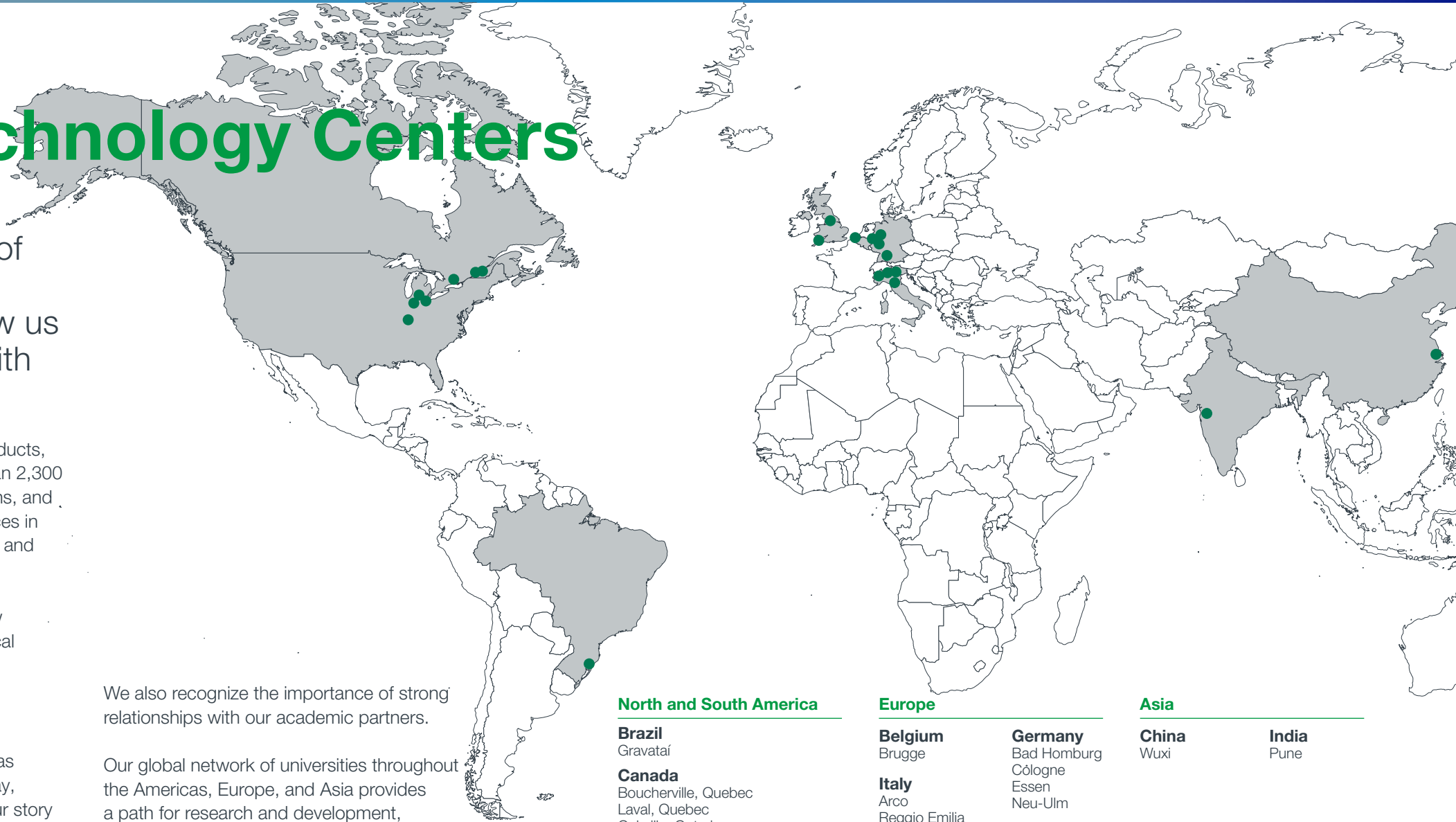

North and South America

Brazil

Gravataí

Canada

Boucherville, Quebec
Laval, Quebec
Oakville, Ontario

United States of America

Lafayette, Indiana
Maumee, Ohio (3)
Paris, Tennessee
Plymouth, Michigan

Europe

Belgium

Brugge

Italy

Arco
Reggio Emilia
Rivoli
Rovereto

Germany

Bad Homburg
Cologne
Essen
Neu-Ulm

UK

Chudleigh
Lindley

Asia

China

Wuxi

India

Pune

Dana's Quality Signature

At Dana, we are innovators and problem solvers. It's what we do all day, every day.

Being problem solvers — *People Finding A Better Way* — gives us invaluable opportunities to gain experience in an open, “no blame” environment where we see challenges as treasures.

It builds relationships and trust.

It means that people share ideas widely that contribute to the team's success and the resulting exchanges inspire innovation for our customers.

Working in this way drives us to faster and higher levels of performance, and along the way we make better data-backed decisions for our customers.

Quality*Focused*
All Day Every Day

Personal Responsibility

When we think of quality at Dana, we think of it as a personal signature that motivates each of us to perform at the highest level. This signature drives our ownership of and accountability for safety, quality, and sustainability.

During 2021, we invested in continuous improvement and electronic tools to promote collaboration and global interconnectivity, and we improved our sustainability footprint through waste elimination in our production processes.

We have seen how the power of our Quality Focused strategy, systems, standards, and tools provide the blueprint for consistently and effectively increasing our performance as well as delivery.

Quality Policy

We commit to customer satisfaction and deliver with **pride and passion**. We champion operational excellence and a **zero-defect approach**. We drive continuous improvement and remain **“Quality Focused All Day, Every Day.”**

Quality Operating System

Dana's Quality Operating System is based on leading industry, quality, customer, and technical standards. The system includes the entire product lifecycle, from initial concept through design, development, production, and post-production support.

It is comprehensive in design and inclusive of Environmental and Health and Safety management processes — utilizing a connected system of tools and methods that are tied to quality-focused behaviors and operational excellence.

Moving Our World

We make products for vehicles and machines that move our world.

There is real pride in knowing that Dana's products and processes enable essential mobility services for people, everywhere. Therefore, our safety protocols ensure that Dana deliverables meet or exceed global vehicle safety requirements.

With that comes an acknowledgment that wherever people work across the Dana organization, we are all responsible for quality.

We reflect this focus on quality through a strong organizational culture that promotes Valuing Others, Inspiring Innovation, Growing Responsibly, and Winning Together.

It's this mindset of operational excellence that drives us to continuously improve and do the right thing "all day, every day."

Holistic Approach

By building in quality and doing it right the first time, we reduce the opportunity for non-conforming material. Through "Stop and Fix," we are empowered to stop the line and identify a potential risk or issue.

Across our manufacturing operations, Dana invests in technologies that support a Quality Focused strategy. This includes manufacturing execution systems that help to ensure quality and efficiency are built into every process.

Anil Parshad

Senior Sales Manager Birmingham, United Kingdom

I'm part of Dana's Light Vehicle sales team based at our Birmingham plant in the heart of the U.K. and am fortunate to work alongside some truly talented individuals.

The desire to "get it done" for each other is unmistakable.

I saw this as we developed the e-Drive unit for the OX Delivers truck — the world's first flat-pack electrified utility vehicle destined for emerging markets in Africa.

To see Dana's e-Powertrain on the world's stage when OX was showcased at COP26 was a true highlight.

With a young family, I'm always thinking of tomorrow. Taking care of our planet drives the choices I make in everyday life.

It's the very same ethos at Dana and cements my decision to join such a passionate and proud team.



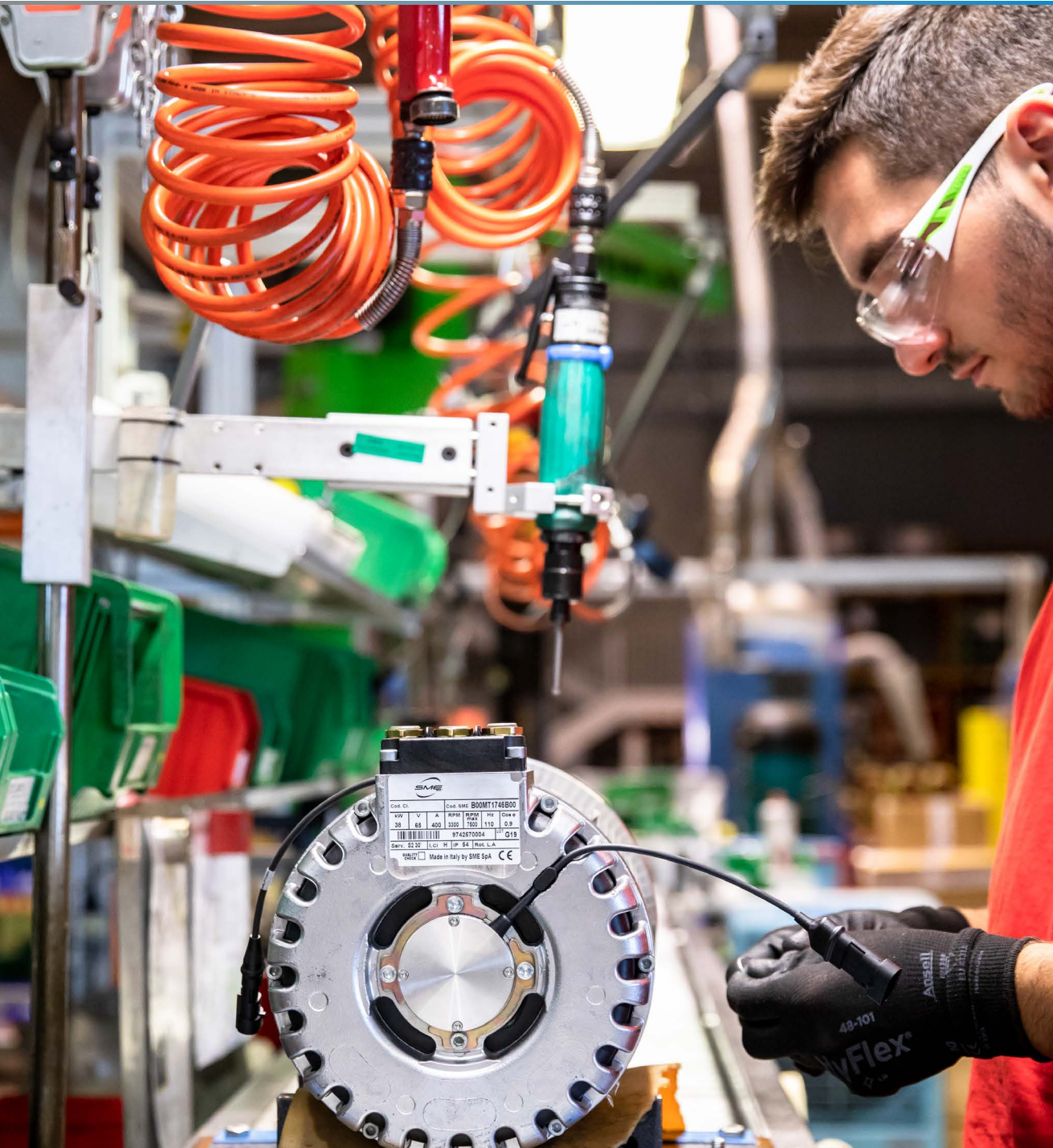

On the product and equipment side of our business, we design for manufacturing and assembly through our Stage Gate and Advanced Quality processes, which build in quality at the source.

For standards and systems, our playbook adopts common principles and methods. We have continued to expand our Quality Focused Toolbox with additional closed loop applications.

To advance our collaborative problem-solving process, we converted two paper-based systems into electronic applications or tools: Fast Response and A3. While Fast Response process addresses internal and external concerns, the electronic A3 tool enhances operational planning and performance aligned with KPIs.

These systems complement each other through structured problem-solving approaches such as the "Plan Do Check Act" cycle and advance our path to sustainability — whether it is a product safety improvement, scrap reduction, or an efficiency project that reduces energy consumption.

We know that promoting standardization increases consistency and eliminates variation. This includes our Manufacturing Enterprise Systems along with

our Connected 4.0 strategy — providing software solutions that advance quality and operational efficiencies into all our value streams. These applications are proactive in the early detection of potential issues and eliminate the opportunity to pass on a defect.

In addition, product traceability is a key requirement at Dana. If an issue arises, traceability enables us to track potential units to a specific build, which reduces risk and cost to both our customer and to Dana.

Electrification Portfolio

As we grow our electrification portfolio — including motors, inverters, and controls — we are continually expanding the use of quality systems earlier in the process to address controls, detection, and compliance.

This allows us to address the needs of our customers in this rapidly growing market segment and deliver of all elements — from a component level to a complete, fully integrated electrified system — across any mobility market in any region of the world.

Quality Success

Dana Kolhapur Awarded Partner-level by John Deere

Dana's Off-Highway team in Kolhapur, India, was awarded the AE Partner Level recognition by John Deere for the third consecutive year.

Despite several challenges, including the impact of the global pandemic and regional flooding, the team prevailed and was able to ensure that they provided the service and commitment required.

The Kolhapur team is committed to ensuring that they achieve this recognition again for 2022 — which would be the fifth consecutive year — providing an opportunity to be entered in Deere's "Hall of Fame."



JOHN DEERE



Dana Named 'Overdrive' Award Winner by General Motors and Honored as Top Supplier for Fifth Consecutive Year

Dana was recognized by General Motors as an Overdrive Award winner as part of GM's 30th annual Supplier of the Year awards, marking the fifth consecutive year Dana has been honored as a top supplier by GM. Dana was one of 31 companies from 12 countries to earn an Overdrive Award for 2021.

First presented in 2012, the Overdrive Award is a distinction reserved for suppliers who display outstanding achievement across the Global Purchasing and Supply Chain organization's key priorities.

These include sustainability, innovation, relationships, total enterprise cost, launch excellence,

and safety.

We are honored to once again be named a top supplier to General Motors with the prestigious Overdrive Award as we continue to deliver a broad portfolio of innovative driveline, sealing, and thermal-management solutions for both electrified and internal-combustion engine vehicles.

A global cross functional GM team selected the 2021 Supplier of the Year and Overdrive Award winners based on performance criteria in Product Purchasing, Global Purchasing and Manufacturing Services, Customer Care and Aftersales and Logistics.



Dana Cardanes Plant Earns Daimler's Masters of Quality Supplier Award for Third Consecutive Year

Dana's Cardanes plant in Querétaro, Mexico, was recognized by Daimler Trucks North America (DTNA) with the Masters of Quality Award for the third consecutive year.

The annual program acknowledges outstanding suppliers that have received high scores based on their quality, delivery, technology, and cost performance — organizations that have demonstrated dedication to continuous improvement of the quality of their products, support to DTNA, and overall performance.

The award, presented by the DTNA supplier management team, further affirms Dana Cardanes' dedication to outstanding quality and timely delivery of components.

Dana China Receives 2021 Best Supplier Award from Gasgoo

Dana was honored with a Best Supplier Award from Gasgoo — a leading automotive industry information service platform — in Shanghai, China, for our Spicer SmartConnect™ Disconnecting All-Wheel-Drive System.

This prestigious award was presented in recognition of Dana's advanced technologies for the auto industry.

Dana Facilities Earn 2020 GM Supplier Quality Excellence Awards

In July 2021, Dana's Power Technology facilities in Mount Forest and Oakville, Ontario, Canada, as well as Chihuahua, Mexico, were awarded a 2020 GM Supplier Quality Excellence Award.

Suppliers who are selected for this prestigious award have met or exceeded a very stringent set of quality performance criteria, including zero disruptions for the year, and have achieved the cross-functional support of the entire GM organization.

Dana PT Yancheng Celebrates Launch of New Plating Line

Dana Power Technologies Yancheng, China, facility celebrated the launch of a new plating line — which includes Dana's patented technology and was first introduced by the team in Oakville, Ontario, Canada.

The new line is designed to speed up our localization process in China and improve the market competitiveness of our thermal products, such as oil coolers and NEV battery cold plates.

The PT Yancheng team overcame many challenges during the pandemic and completed the line installation with remote technical support from the Dana Oakville team.





Corporate culture matters.

Commitment to Ethics and Integrity

Our strong “tone from the top” helps to drive Dana’s sustainability and social responsibility actions.

It also shapes our culture of unwavering dedication to conducting business to the highest ethical standards — all day, every day.

Across our global operating environment, one thing remains constant at Dana — our commitment to integrity and ethical business practices.

We have earned our customers’ trust by delivering outstanding service and an unwavering commitment to ethics in all that we do, person to person.

For almost 120 years, we have been working together to build solutions that support vehicle and engine manufacturers around the world.

As we conduct business in more than 135 countries, each employee is obligated to act with the highest degree of integrity and in full compliance with the law.

Business Conduct and Ethics

We believe that good corporate governance reinforces the message that Dana conducts business in a legal, ethical, and responsible manner with a respect for human rights.

At Dana, business conduct and ethics are addressed through various programs to maintain a culture where each of us feels comfortable asking questions, speaking up, and working toward solutions.

These processes include reporting, investigation and remediation, certification and audit, and continuous training and education.

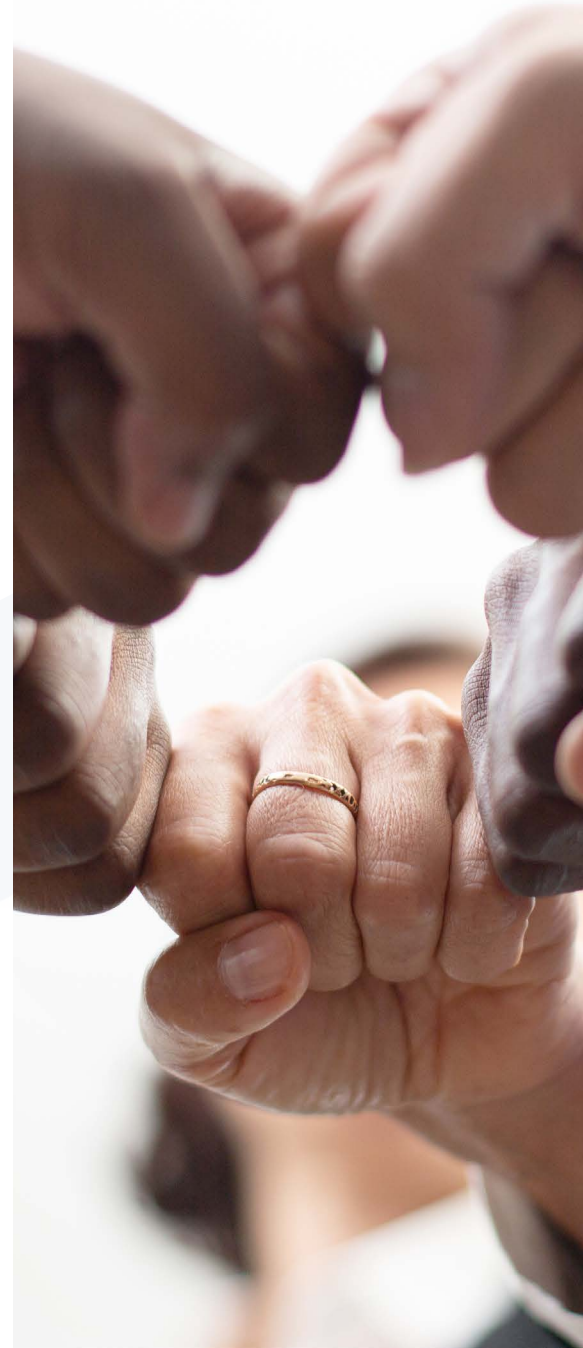

Upon joining Dana, salaried employees undertake a series of mandatory new hire business conduct modules that include promoting honesty, integrity, mutual respect, and compliance with all our policies.

We believe in ongoing training and education to ensure that employees take an active role to understand the policies affecting their job and well-being applicable at their location.

In 2021, these additional mandatory trainings for all employees addressed appropriate workplace behavior, the responsible use of social media, reporting concerns, sustainability, working remotely, and IT security.

Ethics and compliance are also regularly integrated into other training initiatives.

Robust Ethics and Compliance Programs

All internal and external stakeholders benefit from Dana's robust ethics and compliance programs.

Our Standards of Business Conduct are the cornerstone of our business ethics and compliance programs.

They provide guidance to Dana people regarding specific legal and business conduct risk areas.

Dana also maintains other core corporate, operational, and functional policies that govern the conduct of all employees.

The on-boarding process for new hires involves a written acknowledgment of the receipt of the Standards of Business Conduct and other policies.

In addition, all salaried employees are expected to complete an annual questionnaire designed to identify any business conduct concerns.

Dana has a specific policy for handling internal investigations of possible business conduct and ethics violations and other matters involving fraud, theft, ethics, or financial reporting concerns.

This policy establishes an affirmative obligation for employees to report ethics and business conduct matters that come to their attention. It also identifies the process for handling investigations, oversight, reporting, and related issues.

Mider Ji

Environmental, Health, and Safety
Yancheng, China

During my time at Dana, I've had the pleasure to make some life-long friends and work in a team that always goes the distance for each other.

I think that the pandemic has revealed the true essence of life at Dana — we work hard to make sure each other and our partners are safe.

This has meant masks and social distancing over recent times to keep plants running securely.

Working hard to achieve compliance with government safety and environmental permits and approvals.

It's a commitment to duty of care and to support mental wellbeing.

To live the true spirit of Dana Cares in everything we do.



Ethics and Compliance Helpline

Dana maintains a global Ethics and Compliance Helpline, a valuable communication tool available in multiple languages (by both telephone and e-mail) that Dana people may use to anonymously raise concerns related to any alleged ethics or business conduct matters outside of their normal reporting channels.

In 2021, Dana's Ethics and Compliance system logged 142 cases, of which 126 were found to be unsubstantiated after investigation.

Of the remaining cases, Dana's response was based on the facts involved in the matter and included coaching, other formal discipline, or termination of the involved employee.

Continuing to drive our business in an ethical manner will help to ensure the long-term success for our people, our customers, our communities, and our shareholders.

Taking Responsibility

In a fast-paced world, doing the right thing means acting with integrity at all times.



Suzanne Inia

Senior Customer Service Coordinator
Keysborough, Australia

Do right. Do your best. Treat others as you would wish to be treated.

This is the culture that shapes my work at Dana Australia.

Powered by Dana's *People Finding a Better Way* motto, we are a customer-focused assembly plant and distribution center — proudly servicing customers across Australia and New Zealand.

Our culture of customer service is at the heart of our brand.

I'm always impressed at how we continually advance our support to customers — both in swiftly incorporating new technologies and by navigating the many challenges our industry has faced over my ten years at Dana.

More than anything, it's an attitude. For me, it's built upon the strength that comes from a spirit of togetherness, of providing encouragement and care for fellow team members.



Standards of Business Conduct

Our Standards of Business Conduct set forth the behavioral expectations we have of our people as we conduct our operations around the world.

It covers a range of subjects including respect in the workplace, environmental protection, health and safety, use of corporate assets, conflicts of interest, and protection of confidential information among many other topics.

The Standards apply to all employees of Dana. We also expect that anyone acting on our behalf — including contractors, consultants, and other third parties — will observe the same high standards of business conduct and fulfill their contractual obligations.

Dana employees have a responsibility to:

- Conduct business legally and ethically.** To know and comply with our Standards of Business Conduct, as well as the laws, regulations, and policies that apply to their location and role at Dana.

- Ask for guidance.** To reach out any time they are unsure of the proper course of action. This includes supervisors or heads of department, the Dana Law Department, Human Resources, or the Internal Audit Department.
- Share concerns if misconduct is suspected.** To realize that doing nothing or looking the other way is never acceptable and can have serious consequences for them and our company.
- Never compromise.** To always conduct business the right way — and with the right values — consistent with our Standards

Our [Standards of Business Conduct](#) has been translated into 20 languages and is also publicly available via our website.

Refreshed Supplier Code of Business Conduct

SUPPLIER CODE OF BUSINESS CONDUCT

Our Global Commitment to Integrity

serve to advance the performance of our companies to our mutual benefit. Therefore, compliance with Dana's Supplier Code of Conduct is a mandatory component of all Dana purchase contracts.

We appreciate your thorough review of the standards set forth in this document.

1 DANA SUPPLIER CODE OF BUSINESS CONDUCT

trafficking or physically abusive disciplinary practices. Dana's suppliers must strive to respect human dignity and never engage in human rights abuses.

A. Wages: Dana also expects its suppliers to provide employee wage and benefit levels that – as a minimum – satisfy basic needs in light of local conditions. Suppliers must abide by all applicable laws related to limits on regular and overtime working hours and compensation.

B. Ethical Recruitment: Dana expects its suppliers to engage in ethical recruiting practices. Suppliers must not mislead or defraud potential workers about the nature of their work. Suppliers cannot request employees to pay recruitment fees or deny them access to documents for passports or other government-issued identification.

C. Employees Right to Freedom of Association: Suppliers should promote activities in the best interest of employees and provide them with a process where their voices can be heard without fear of intimidation, retaliation, or harassment. We also expect our suppliers to respect freedom of association of its employees in accordance with local laws.

2 DANA SUPPLIER CODE OF BUSINESS CONDUCT

Dana operates at scale. We employ 40,000 people across 139 major facilities in 31 countries. We ship to 14,000 customers in 135 countries. We recognize that Dana is an essential component in a global supply chain serving customers worldwide.

We know that our performance, and the performance of our supply chain, is important to our customers and positively impacts their sustainability objectives.

Therefore, it is essential that our suppliers also understand and appreciate the standards of business conduct that are expected of any company that conducts business with Dana.

Clear and Consistent Standards

As ever, communication is key. Therefore in 2021, we refreshed our Supplier Code of Business Conduct, moving to an interactive format with user-friendly navigation capabilities.

We wanted to further an engaging experience whether viewed on a PC, tablet, or smartphone.

Enhanced graphics and use of images give the document a more modern look and feel, underpinning our goal to continue communicating

clearly and consistently and reinforcing Dana's no-compromise approach when it comes to doing business in an ethical manner and with respect for our people and the communities in which we live.

We believe that this commitment will benefit our customers and other stakeholders affected by Dana's activities. For many reasons, it is, quite simply, the right thing to do.

Among a comprehensive list of standards, our code addresses:

- Respect for People: Inclusion and Diversity
- Safe and Positive Workplaces
- Environmental Protection and Sustainability
- Conflict Minerals and Other Product Origin Obligations
- Product Safety
- Gifts, Favors, and Entertainment
- Conflicts of Interest
- Negotiating Fairly and Honestly

To ensure we reinforce these values clearly and consistently around the world, our [Supplier Code of Business Conduct](#) has been translated into 20 languages and is publicly available via our website.

All Eyes on Cybersecurity

Our global cybersecurity team protects the data and integrity of computing devices belonging to, or connecting to, Dana's network — addressing reputational, operational, and compliance implications of cybersecurity risks.

Cybersecurity is the practice of protecting systems, networks, and programs from digital attacks.

A priority focus on operational excellence and ensuring our Dana systems are maintained and upgraded has been key to protecting our people and our customers.

Throughout 2021, a proactive focus on next generation endpoint protection and vulnerability management has been an essential strength from a cybersecurity perspective.

We know that cyberattacks are usually aimed at accessing, changing, or destroying sensitive information; extorting money from users; or interrupting normal business processes.

As such, training and development will continue to play an important role in protecting systems from cyberattacks.

Dana employees undertake mandatory annual cybersecurity training to educate them on dangerous threats so that they can learn to recognize and report real attacks — in addition to supplemental training programs available each year.

We locked-in the advances made in securely establishing and stabilizing a remote work environment to accommodate a 30-fold increase in the number of daily remote users due to the ongoing global pandemic.

If people needed to get to a Dana application, we ensured that the correct authentication protocols were in place.

This encompassed moving thousands of employees to Microsoft Teams® and registering thousands of colleagues and external partners for multi-factor authentication to boost additional security across our applications.

Dana's Information Security Policy aligns to ISO 27001 and follows the National Institute of Standards and Technology (NIST) framework controls. We conduct self-assessments each year and third-party audits against the NIST framework.

Four key tenets underpin Dana's robust cyber security strategy as it engages across the entire company to protect our people and increasingly digitized business operations.

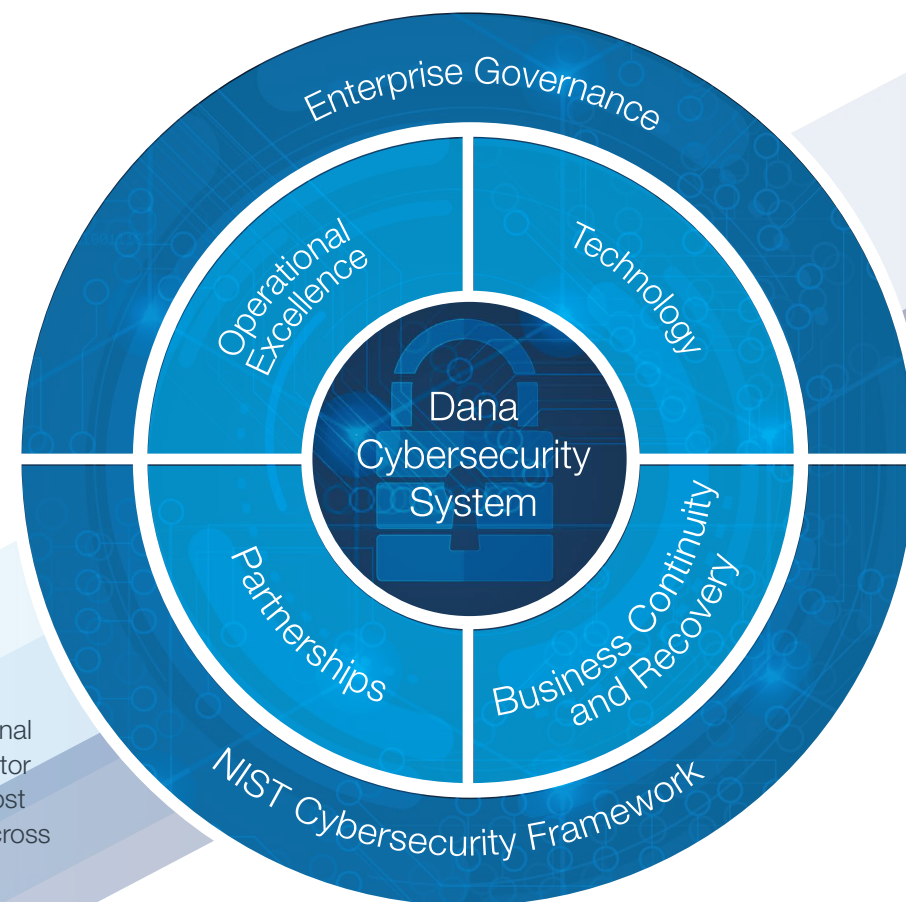

Dana Leadership

Board of Directors

Ernesto M. Hernández ^{1, 4}

Retired President and Managing Director of General Motors de México

Director since 2022

Gary Hu ^{2, 4}

Portfolio Manager for Icahn Capital LP

Director since 2022

Brett M. Icahn ^{1, 3}

Portfolio Manager for Icahn Capital LP

Director since 2022

James K. Kamsickas

Chairman and Chief Executive Officer of Dana Incorporated

Director since 2015

Virginia A. Kamsky ^{2, 3*}

Chair and Chief Executive Officer of Kamsky Associates, Inc.

Director since 2011

Bridget E. Karlin ^{3, 4}

Senior Vice President of Information Technology at Kaiser Permanente

Director since 2020

Michael J. Mack, Jr. ^{1*, 2, 5}

Retired Group President of John Deere Financial Services, Global Human Resources, and Public Affairs at Deere & Co.

Director since 2018

R. Bruce McDonald ^{1, 2*, 5}

Retired Chairman and Chief Executive Officer of Adient plc

Director since 2014

Diarmuid B. O’Connell ^{2, 4*}

Former Vice President of Tesla, Inc.

Director since 2018

Keith E. Wandell ^{3, †}

Retired President and Chief Executive Officer, and Chairman of Harley-Davidson, Inc.

Director since 2008

¹ Member: Compensation Committee

² Member: Audit Committee

³ Member: Nominating and Corporate Governance Committee

⁴ Member: Technology and Sustainability Committee

⁵ Financial Expert

* Committee Chair

† Lead Independent Director

Dana Leadership

Corporate Officers

James K. Kamsickas

Chairman and
Chief Executive Officer

Aziz S. Aghili

Executive Vice President and
President of Heavy Vehicle

Chris J. Clark

Senior Vice President,
Global Operations

Jeroen B. Decler

Senior Vice President,
Off-Highway Drive and Motion Systems

Christophe J. Dominiak

Senior Vice President and
Chief Technology Officer

Matthew H. Fahnestock

Senior Vice President and
Chief Information Officer

Byron S. Foster

Senior Vice President and
President of Light Vehicle Drive Systems

John F. Geddes

Vice President and
Treasurer

James D. Kellett

Vice President and
Chief Accounting Officer

Timothy R. Kraus

Senior Vice President and
Chief Financial Officer

Ryan W. Laskey

Senior Vice President, Commercial Vehicle
Drive and Motion Systems

Douglas H. Liedberg

Senior Vice President, General Counsel,
and Secretary, Chief Compliance and
Sustainability Officer

Seth A. Metzger

Senior Vice President,
Electrification

Maureen S. Pittenger

Senior Vice President and Chief
Human Resources Officer

M. Craig Price

Senior Vice President,
Purchasing and Supplier Development

Antonio Valencia

Senior Vice President, Global Electrification
and President of Power Technologies



Appendix

Methodology

Using the Global Reporting Initiative (GRI), Sustainable Accounting Standards Board (SASB), and Task Force on Climate-related Financial Disclosures (TCFD) guidance, we identified possible topics, prioritized the topics, validated the results, and adopted the list of material topics for our Sustainability and Social Responsibility reporting strategy.

Step 1: Identification

- Identified internal and external sources of information to score for prioritization.
- Benchmarked our competitors/peers on sustainability and social responsibility practices.
- Created a high-level value chain map to identify sustainability and social responsibility impacts, risks, opportunities, and boundaries.

Step 2: Prioritization

- Gathered perceptions of stakeholder priorities based on associated facts and evidence, including 18 internal stakeholder interviews, 21 external stakeholder interviews, and internal/external score sourcing.
- Scored and synthesized feedback to present final materiality results reflecting feedback from stakeholders, peer benchmarking, and relevant industry standards and studies.

Step 3: Validation

- Validated the materiality matrix through discussion with key leaders about prioritized material topics, associated boundaries, and opportunities.

Step 4: Adoption

- Determined and/or refined the management approach regarding the most significant topics.
- Set or refined goals, performance indicators, strategies, partnerships, and internal controls.
- Established the materiality assessment as the basis for ongoing ESG strategy, goal setting, and reporting.

Material Topics

Issues

1. Innovation and Product Lifecycle
2. Talent Management
3. Occupational Health, Safety and Wellness
4. Ethical Business Practices
5. Diversity and Equal Opportunity
6. Business Continuity / Risk Mitigation / Supply Chain
7. Product Quality and Safety
8. Energy Consumption and Emissions
9. Solid Waste
10. Water and Effluents



Stakeholder Engagement

Continuous engagement and regular dialogue with our seven defined stakeholder groups, through formal and informal processes, provides us the opportunity to innovate and proactively manage the emerging environmental, social, and governance (ESG) needs and risks.

In addition to ongoing internal stakeholder engagement, we regularly engage with our external stakeholders on trending and emerging issues that matter to them through inquiries and requests for information related to our ESG practices as well as through periodic surveys answered at the request of various customers and investors.

In addition to engaging with internal and external stakeholders to evolve our ESG execution, we understand that increased transparency helps us effectively improve our business over the long term.

A list of external charters and associations Dana is actively engaged with include:

- American Bar Association Diversity & Inclusion Initiative
- American Society of Safety Professionals (ASSP)
- Association of Equipment Manufacturers (AEM)
- Automotive Industry Action Group (AIAG)
- Board of Certified Safety Professionals (CSP)
- CEO Action for Diversity & Inclusion
- Center for Automotive Diversity, Inclusion & Advancement (CADIA)
- Chartered Institute of Procurement & Supply (CIPS)
- CDP (fka Carbon Disclosure Project)
- Ethisphere Institute
- Global Reporting Initiative (GRI)
- Great Lakes Women's Business Council (Great Lakes WBC)
- Human Rights Campaign Corporate Equality Index
- Institute of Hazardous Materials Management (IHMM)
- Institutional Shareholder Services (ISS)
- International Organization for Standardization (ISO)
- Leadership in Energy & Environmental Design (LEED)
- Manufacturers Alliance for Productivity and Innovation (MAPI)
- National Institute of Standards and Technology (NIST)
- National Society of Black Engineers (NSBE)
- S&P Global Corporate Sustainability Assessment (CSA)
- Science Based Target Initiative (SBTi)
- Sustainable Accounting Standards Board (SASB)
- United Nations Sustainable Development Goals (SDGs)
- Task Force on Climate-related Financial Disclosures (TCFD)

United Nations Sustainable Development Goals Index

The Global Reporting Initiative is the independent international organization that helps businesses and other organizations take responsibility for their impacts, by providing global common language to communicate those impacts. They provide the world's most widely used standards for sustainability reporting – the GRI Standards.

The 2030 Agenda for Sustainable Development, adopted by all United Nations Member States in 2015, provides a shared blueprint for peace and prosperity for people and the planet, now and into the future. At its heart are the 17 Sustainable Development Goals (SDGs), which are an urgent call for action by all countries - developed and developing - in a global partnership. They recognize that ending poverty and other

deprivations must go hand-in-hand with strategies that improve health and education, reduce inequality, and spur economic growth – all while tackling climate change and working to preserve our oceans and forests.

Within the report index, Dana is providing the linkages between the reporting framework content – Global Reporting Initiative (GRI), Sustainable Accounting Standards Board (SASB), and Task Force on Climate-related Financial Disclosures (TCFD) – and their relationship with the 17 United Nations SDGs listed to the right.



Global Reporting Initiative (GRI) Index

The Global Reporting Initiative is the independent international organization that helps businesses and other organizations take responsibility for their impacts, by providing global common language to communicate those impacts. They provide the world’s most widely used standards for sustainability reporting – the GRI Standards.

Disclosure Number	Disclosure Title	2021 Response	SDGs
GRI 102: General Disclosures			
Organizational Profile			
102-1	Name of the organization	Dana Incorporated	NA
102-2	Activities, brands, products, and services	Dana 2021 Sustainability & Social Responsibility Report: Dana: Products Dana 2021 Annual Report pages 1 - 17	NA
102-3	Location and headquarters	Dana’s corporate offices are located at: Dana Incorporated 3939 Technology Drive Maumee, OH 43537, USA	NA
102-4	Location of operations	Locations	NA
102-5	Ownership and legal form	Dana Incorporated (NYSE: DAN) is a publicly held corporation incorporated in the state of Delaware. Our shares trade on the New York Stock Exchange.	NA

102-6	Markets served	Dana 2021 Sustainability & Social Responsibility Report: Dana: Business Units Dana 2021 10-K pages 1 & 2	NA
102-7	Scale of the organization	Dana 2021 Sustainability & Social Responsibility Report: Sales Snapshot Dana 2021 10-K page 3 & 4	NA
102-8	Information on employees and other workers	Dana 2021 Sustainability & Social Responsibility Report: Employment Data Dana 2021 10-K pages 5 & 6	NA
102-9	Supply chain	Dana 2021 Sustainability & Social Responsibility Report: Advancing a World-class Sustainable Supply Chain Dana 2021 10-K page 3	NA
102-10	Significant changes to the organization and its supply chain	Dana 2021 Sustainability & Social Responsibility Report: e-Propulsion Dana 2021 10-K pages 15 - 19	NA
102-11	Precautionary principle or approach	Dana has applied the precautionary principle in its approach to managing greenhouse gas emissions and their effect on global climate change.	NA
102-12	External initiatives	Dana 2021 Sustainability & Social Responsibility Report: Appendix - Stakeholder Engagement	SDG 17
102-13	Membership of associations	Dana 2021 Sustainability & Social Responsibility Report: Appendix - Stakeholder Engagement	SDG 17
Strategy			
102-14	Statement from senior decision-maker	Dana 2021 Sustainability & Social Responsibility Report: Message from the CEO	NA
102-15	Key impacts, risks, and opportunities	Dana 2021 10-K pages 7 - 13	NA

Ethics and Integrity			
102-16	Values, principles, standards, and norms of behavior	Dana 2021 Sustainability & Social Responsibility Report: Culture Matters Standards of Business Conduct	SDG 3
102-17	Mechanisms for advice and concerns about ethics	Dana 2021 Sustainability & Social Responsibility Report: Culture Matters Internal Investigations Policy	SDG 16
Governance			
102-18	Governance structure	Dana 2021 Sustainability & Social Responsibility Report: Culture Matters Technology & Sustainability Committee Sustainability & Social Responsibility Governance	SDG 16
102-19	Delegating authority	Technology & Sustainability Committee Sustainability & Social Responsibility Governance	SDG 16
102-20	Executive-level responsibility for economic, environmental, and social topics	Sustainability & Social Responsibility Governance	SDG 16
102-21	Consulting stakeholders on economic, environmental, and social topics	Dana 2021 Sustainability & Social Responsibility Report: Appendix - Methodology	SDG 16
102-22	Composition of the highest governance body and its committees	Board of Directors Corporate Governance Sustainability & Social Responsibility Governance Dana 2022 Proxy, page 42	SDG 16
102-23	Chair of the highest governance body	Dana 2022 Proxy , pages 39 - 41	SDG 16

102-24	Nominating and selecting the highest governance body	Corporate Governance Dana 2022 Proxy , pages 35 - 38 Director Selection and Retention Guidelines	SDG 16
102-25	Conflicts of interest	Standards of Business Conduct Policy for Members of the Board of Directors	SDG 16
102-26	Role of highest governance body in setting purpose, values, and strategy	Corporate Governance Guidelines	SDG 16
102-27	Collective knowledge of highest governance body	Dana Board of Directors Dana 2022 Proxy , pages 35 - 38	SDG 16
102-28	Evaluating the highest governance body's performance	Corporate Governance Guidelines , page 6 Dana 2022 Proxy , page 39	SDG 16
102-29	Identifying and managing economic, environmental, and social impacts	Technology & Sustainability Committee Charter , page 1, items 5 - 7 Sustainability & Social Responsibility Governance	SDG 16
102-30	Effectiveness of risk management processes	Dana 2021 10-K pages 7 - 13 Dana 2022 Proxy , page 40	SDG 16
102-31	Review of economic, environmental, and social topics	Sustainability & Social Responsibility Governance Dana 2022 Proxy , page 42	SDG 16
102-32	Highest governance body's role in sustainability reporting	Technology & Sustainability Committee Charter Sustainability & Social Responsibility Governance	SDG 16

102-33	Communicating critical concerns	<p>Go to www.dana.com to find the latest investor relations information about Dana, including stock quotes, news releases, and financial data.</p> <p>Requests for information may be directed to:</p> <p>surDana Incorporated Investor Relations P.O. Box 1000 Maumee, OH 43537, USA</p> <p>E-mail: InvestorRelations@dana.com</p> <p>Dana's Investor Line: 800-537-8823</p> <p>Through this 24-hour phone service, a caller may leave his or her name with a message, and the call will be returned by a Dana representative.</p>	SDG 16
102-34	Nature and total number of critical concerns	This information is considered confidential.	SDG 16
102-35	Remuneration policies	Dana 2022 Proxy , pages 19 - 21	SDG 16
102-36	Process for determining remuneration	Dana 2022 Proxy , pages 6 - 19	SDG 16
102-37	Stakeholders' involvement in remuneration	Dana 2022 Proxy , page 49	SDG 16
102-38	Annual total compensation ratio	Dana 2022 Proxy , page 34	SDG 16
102-39	Percentage increase in annual total compensation ratio	Dana 2022 Proxy , page 34	SDG 16

Stakeholder Engagement			
102-40	List of stakeholder groups	Dana 2021 Sustainability & Social Responsibility Report: Appendix - Methodology	NA
102-41	Collective bargaining agreements	Dana recognizes and supports freedom of association and collective bargaining rights as required by applicable law. In 2021, 53% of all employees were covered by a collective bargaining agreement.	NA
102-42	Identifying and selecting stakeholders	Dana 2021 Sustainability & Social Responsibility Report: Appendix - Methodology	NA
102-43	Approach to stakeholder engagement	Dana 2021 Sustainability & Social Responsibility Report: Appendix - Methodology	NA
102-44	Key topics and concerns raised	Dana 2021 Sustainability & Social Responsibility Report, Appendix - Methodology	NA
Reporting Practices			
102-45	Entities included in the consolidated financial statements	Dana 2021 10-K, page 12	NA
102-46	Defining report content and topic Boundaries	Dana 2021 Sustainability & Social Responsibility Report: Appendix - Methodology	NA
102-47	List of material topics	Dana 2021 Sustainability & Social Responsibility Report: Appendix - Methodology	NA
102-48	Restatements of information	None	NA
102-49	Changes in reporting	None	NA
102-50	Reporting period	Dana 2021 Sustainability & Social Responsibility Report: Cover Page	NA
102-51	Date of most recent report	April 2022	NA

102-52	Reporting cycle	Dana 2021 Sustainability & Social Responsibility Report: Cover Page	NA
102-53	Contact point for questions regarding the report	Please send any questions regarding the report to: sustainability@dana.com	NA
102-54	Claims of reporting in accordance with the GRI Standards	Dana 2021 Sustainability & Social Responsibility Report: Appendix - GRI Content Index	NA
102-55	GRI content index	Dana 2021 Sustainability & Social Responsibility Report: Appendix - GRI Content Index	NA
102-56	External assurance	The Dana 2021 Sustainability & Social Responsibility Report has not been externally reviewed and verified as of the release date.	SDG 16
Topic-Specific Standards			
GRI 204: Procurement Practices			
103-1	Explanation of the material topic and its boundary	Dana 2021 Sustainability & Social Responsibility Report: Appendix / Methodology	NA
103-2	The management approach and its components	Dana 2021 Sustainability & Social Responsibility Report: Emissions Reduction / Sustainable Supply Chain	SDG 12
103-3	Evaluation of the management approach	Dana 2021 Sustainability & Social Responsibility Report: Emissions Reduction / Sustainable Supply Chain	SDG 12
204-1	Proportion of spending on local suppliers	Dana works with thousands of suppliers around the world, including many suppliers located near our customers' operations.	SDG 12
GRI 205: Anti-Corruption			
103-1	Explanation of the material topic and its boundary	Dana 2021 Sustainability & Social Responsibility Report: Appendix / Methodology	NA
103-2	The management approach and its components	Dana 2021 Sustainability & Social Responsibility Report: Culture Matters / Commitment to Ethics and Integrity	SDG 16

103-3	Evaluation of the management approach	Dana 2021 Sustainability & Social Responsibility Report: Culture Matters / Commitment to Ethics and Integrity	SDG 16
205-1	Operations assessed for risks related to corruption	Dana has a robust internal audit program including audit procedures specifically focused on business conduct.	SDG 16
205-2	Communication and training about anti-corruption policies and procedures	Dana 2021 Sustainability & Social Responsibility Report: Culture Matters / Commitment to Ethics and Integrity	SDG 16
205-3	Confirmed incidents of corruption and actions taken	Dana 2021 Sustainability & Social Responsibility Report: Culture Matters / Ethics and Compliance Hotline	SDG 16
GRI 206: Anti-Competitive Behavior			
103-1	Explanation of the material topic and its boundary	Dana 2021 Sustainability & Social Responsibility Report: Appendix / Methodology	NA
103-2	The management approach and its components	Dana 2021 Sustainability & Social Responsibility Report: Culture Matters / Commitment to Ethics and Integrity	SDG 16
103-3	Evaluation of the management approach	Dana 2021 Sustainability & Social Responsibility Report: Culture Matters / Commitment to Ethics and Integrity	SDG 16
206-1	Legal actions for anti-competitive behavior, anti-trust, and monopoly practices	Dana's public filings would identify any significant pending proceedings.	SDG 16
GRI 302: Energy			
103-1	Explanation of the material topic and its boundary	Dana 2021 Sustainability & Social Responsibility Report: Appendix / Methodology	NA
103-2	The management approach and its components	Dana 2021 Sustainability & Social Responsibility Report: Taking Action	SDG 12,13
103-3	Evaluation of the management approach	Dana 2021 Sustainability & Social Responsibility Report: Taking Action	SDG 12,13
302-1	Energy consumption within the organization	98.4% electricity purchased from traditional energy providers Dana 2021 Sustainability & Social Responsibility Report: Taking Action and the graph detailing Total Energy Consumption (MWh)	SDG 7,12,13
302-2	Energy consumption outside of the organization	Scope 3 emissions for 2021 will be included in the 2022 CDP submission	SDG 7,12,13

302-3	Energy intensity	Dana 2021 Sustainability & Social Responsibility Report: Taking Action Normalized Energy Consumption (kWh per hour worked) 2019: 28.42 kWh per hour worked 2020: 27.89 kWh per hour worked 2021: 24.88 kWh per hour worked Normalized GHG Emissions (kWh per mil \$ sales) 2019: 234,979 kWh per mil \$ sales 2020: 244,323 kWh per mil \$ sales 2021: 208,702 kWh per mil \$ sales	SDG 7,12,13
302-4	Reduction of energy consumption	Dana 2021 Sustainability & Social Responsibility Report: Taking Action and the graph detailing Total Energy Consumption (MWh)	SDG 7,12,13
302-5	Reduction in energy requirements of products and services	Dana 2021 Sustainability & Social Responsibility Report: e-Propulsion	SDG 9,13
GRI 303: Water & Effluents			
103-1	Explanation of the material topic and its boundary	Dana 2021 Sustainability & Social Responsibility Report: Appendix / Methodology	NA
103-2	The management approach and its components	Dana 2021 Sustainability & Social Responsibility Report: Taking Action	SDG 12,14
103-3	Evaluation of the management approach	Dana 2021 Sustainability & Social Responsibility Report: Taking Action	SDG 12,14
303-1	Interactions with water as a shared resource	Water interactions for 2021 will be included in the 2021 CDP submission	SDG 12,14
303-2	Management of water discharge-related impacts	Water discharge for 2021 will be included in the 2021 CDP submission	SDG 12,14

303-3	Water withdrawal	Dana 2021 Sustainability & Social Responsibility Report: Taking Action Total Water Consumption (m ³) 2019: 3,506,106 m ³ 2020: 3,270,472 m ³ 2021: 3,344,551 m ³ Total Normalized Water Consumption (m ³ per hour worked) 2019: 0.0492 m ³ per hour worked 2020: 0.0525 m ³ per hour worked 2021: 0.0446 m ³ per hour worked Total Normalized Water Consumption (m ³ per mil \$ sales) 2019: 407 m ³ per mil \$ sales 2020: 460 m ³ per mil \$ sales 2021: 374 m ³ per mil \$ sales	SDG 6,12,14
303-4	Water discharge	Water discharge for 2021 will be included in the 2022 CDP submission	SDG 12,14
303-5	Water consumption	Water consumption for 2021 will be included in the 2022 CDP submission	SDG 6,12,14
GRI 305: Emissions			
103-1	Explanation of the material topic and its boundary	Dana 2021 Sustainability & Social Responsibility Report: Appendix / Methodology	NA
103-2	The management approach and its components	Dana 2021 Sustainability & Social Responsibility Report: Taking Action	SDG 7,12,13
103-3	Evaluation of the management approach	Dana 2021 Sustainability & Social Responsibility Report: Taking Action	SDG 7,12,13

305-1	Energy: Direct (Scope 1) GHG emissions	Dana 2021 Sustainability & Social Responsibility Report: Taking Action Scope 1 GHG Emissions (kg CO ₂ -e): 2019: 162,407,000 kg 2020: 133,223,000 kg 2021: 145,236,000 kg 2021 Scope 1 Energy Consumption by Type (MWh): Natural Gas: 694,359 MWh LPG: 52,772 MWh Diesel: 10,596 MWh Gasoline: 1,111 MWh	SDG 7,12,13
305-2	Energy: Indirect (Scope 2) GHG emissions	Dana 2021 Sustainability & Social Responsibility Report: Taking Action Scope 2 GHG Emissions (kg CO ₂ -e) 2019: 455,435,000 kg 2020: 388,347,000 kg 2021: 401,322,000 kg 2021 Scope 2 Energy Consumption by Type (MWh) Grid Electricity: 1,090,789 MWh Renewable Electricity: 17,210 MWh	SDG 7,12,13
305-3	Energy: Other indirect (Scope 3) GHG emissions	Scope 3 emissions information for 2021 will be included in the 2022 CDP submission.	SDG 7,12,13
305-4	GHG emissions intensity	Dana 2021 Sustainability & Social Responsibility Report: Taking Action Normalized GHG Emissions (kg CO ₂ -e per hour worked) 2019: 8.67 kg CO ₂ -e per hour worked 2020: 8.38 kg CO ₂ -e per hour worked 2021: 7.28 kg CO ₂ -e per hour worked Normalized GHG Emissions (kg CO ₂ -e per mil \$ sales) 2019: 71,675 kg CO ₂ -e per mil \$ sales 2020: 73,399 kg CO ₂ -e per mil \$ sales 2021: 61,102 kg CO ₂ -e per mil \$ sales	SDG 7,12,13

305-5	Reduction of GHG emissions	Dana 2021 Sustainability & Social Responsibility Report: Taking Action and graph detailing Total Greenhouse Gas Emissions (kg CO ₂ -e)	SDG 7,12,13
305-6	Emissions of ozone-depleting substances (ODS)	5,105,269 kg included in the calculation for Scope 1 GHG emissions	SDG 7,12,13
305-7	Nitrogen oxides (NOx), sulfur oxides (SOx), and other significant air emissions	Significant emissions from combustion of fuels in 2021, include: Particulate Matter: 14,521 kg Nitrogen Oxides: 200,904 kg Sulfur Oxides: 5,853 kg Carbon Monoxide: 116,988 kg Volatile Organic Compounds: 18,647 kg Hazardous Air Pollutants: 94 kg Calculation Source: AP-42 Fifth Edition, Tables 3.3-1, 10/96 Update	SDG 12,13
GRI 306: Effluents and Waste			
103-1	Explanation of the material topic and its boundary	Dana 2021 Sustainability & Social Responsibility Report: Appendix / Methodology	NA
103-2	The management approach and its components	Dana 2021 Sustainability & Social Responsibility Report: Taking Action	SDG 12,15
103-3	Evaluation of the management approach	Dana 2021 Sustainability & Social Responsibility Report: Taking Action	SDG 12,15

306-1	Waste generation and significant waste-related impacts	Dana 2021 Sustainability & Social Responsibility Report: Taking Action 2021 Hazardous Waste by Treatment Method (kg) Recovery: 8,211,321 kg Other (Chem Phys): 2,756,636 kg Recycle: 739,246 kg Incineration: 577,060 kg Reuse: 285,146 kg Compost: 51,650 kg Landfill: 15,676 kg 2021 Non-Hazardous Waste by Treatment Method (kg) Recycle: 140,504,621 kg Landfill: 20,257,033 kg Other (Chem Phys): 8,373,837 kg Reuse: 2,125,534 kg Recovery: 372,853 kg Incineration: 366,611 kg Compost: 72,200 kg	SDG 12,15
306-2	Management of significant waste-related impacts	Dana 2021 Sustainability & Social Responsibility Report: Taking Action Refer to 2021 Hazardous and Non-Hazardous Waste Data (above)	SDG 12,15
306-3	Waste generated	Dana 2021 Sustainability & Social Responsibility Report: Taking Action Refer to 2021 Hazardous and Non-Hazardous Waste Data (above)	SDG 12,15
306-4	Waste diverted from disposal	Dana 2021 Sustainability & Social Responsibility Report: Taking Action Refer to 2021 Hazardous and Non-Hazardous Waste Data (above)	SDG 12,15
306-5	Waste directed to disposal	Dana 2021 Sustainability & Social Responsibility Report: Taking Action Refer to 2021 Hazardous and Non-Hazardous Waste Data (above)	SDG 12,15

GRI 307: Environmental Compliance			
103-1	Explanation of the material topic and its boundary	Dana 2021 Sustainability & Social Responsibility Report: Appendix / Methodology	NA
103-2	The management approach and its components	Dana 2021 Sustainability & Social Responsibility Report: Value Others / Safety First	SDG 13,14,15,16
103-3	Evaluation of the management approach	Dana 2021 Sustainability & Social Responsibility Report: Value Others / Safety First	SDG 13,14,15,16
307-1	Non-compliance with environmental laws and regulations	No significant fines and/or non-monetary sanctions were levied against any of our sites in 2021. Dana 2021 10-K, page 6	SDG 13,14,15,16
GRI 308: Supplier Environmental Assessment			
103-1	Explanation of the material topic and its boundary	Dana 2021 Sustainability & Social Responsibility Report: Appendix / Methodology	NA
103-2	The management approach and its components	Dana 2021 Sustainability & Social Responsibility Report: Emissions Reduction / Sustainable Supply Chain	SDG 12,16
103-3	Evaluation of the management approach	Dana 2021 Sustainability & Social Responsibility Report: Emissions Reduction / Sustainable Supply Chain	SDG 12,16
308-1	New suppliers that were screened using the environmental criteria	Dana 2021 Sustainability & Social Responsibility Report: Emissions Reduction / Sustainable Supply Chain	SDG 12,16
308-2	Negative environmental impacts in the supply chain and actions taken	Dana 2021 Sustainability & Social Responsibility Report: Emissions Reduction / Sustainable Supply Chain	SDG 12,16
GRI 401: Employment			
103-1	Explanation of the material topic and its boundary	Dana 2021 Sustainability & Social Responsibility Report: Appendix / Methodology	NA
103-2	The management approach and its components	Dana 2021 Sustainability & Social Responsibility Report: Value Others / People Development	SDG 8
103-3	Evaluation of the management approach	Dana 2021 Sustainability & Social Responsibility Report: Value Others / People Development	SDG 8
401-1	New employee hires and employee turnover	Dana 2021 Sustainability & Social Responsibility Report: Value Others / Employment Data	SDG 8

401-2	Benefits provided to full-time employees that are not provided to temporary or part-time employees	<p>Dana 2021 Sustainability & Social Responsibility Report: Value Others / The Importance of Health and Well-Being.</p> <p>Dana 2021 10-K, pages 5 & 6</p> <p>Careers Website</p>	SDG 3,8
401-3	Parental leave	This information is being collected and analyzed.	SDG 3,8
GRI 403: Occupational Health & Safety			
103-1	Explanation of the material topic and its boundary	Dana 2021 Sustainability & Social Responsibility Report: Appendix / Methodology	NA
103-2	The management approach and its components	Dana 2021 Sustainability & Social Responsibility Report: Value Others / Safety First	SDG 3,8
103-3	Evaluation of the management approach	Dana 2021 Sustainability & Social Responsibility Report: Value Others / Safety First	SDG 3,8
403-1	Occupational health and safety management system	Dana 2021 Sustainability & Social Responsibility Report: Value Others / Reaching ISO 45001 Certification Goal	SDG 3,8
403-2	Hazard identification, risk assessment, and incident investigation	<p>Dana 2021 Sustainability & Social Responsibility Report: Value Others / Reaching ISO 45001 Certification Goal</p> <p>In 2021, an additional 26 manufacturing sites achieved certification to the ISO 45001 OHS Management System. Certified sites are required to implement a robust hazard identification, risk assessment and incident investigation process as a requirement for 3rd party certification.</p>	SDG 3,8
403-3	Occupational health services	Dana facilities maintain robust occupational health services while also protecting worker confidential information.	SDG 3,8
403-4	Worker participation, consultation, and communication on occupational health and safety	<p>Dana 2021 Sustainability & Social Responsibility Report: Value Others / Reaching ISO 45001 Certification Goal</p> <p>In 2021, an additional 26 manufacturing sites achieved certification to the ISO 45001 OHS Management System. Certified sites are required to implement a robust hazard identification, risk assessment and incident investigation process as a requirement for 3rd party certification.</p>	SDG 3,8

403-5	Worker training on occupational health and safety	Dana 2021 Sustainability & Social Responsibility Report: Value Others / Reaching ISO 45001 Certification Goal In 2021, an additional 26 manufacturing sites achieved certification to the ISO 45001 OHS Management System. Certified sites are required to implement a robust hazard identification, risk assessment and incident investigation process as a requirement for 3 rd party certification.	SDG 3,8
403-6	Promotion of worker health	Dana 2021 Sustainability & Social Responsibility Report: Value Others / Safety First Dana 2021 Sustainability & Social Responsibility Report: Value Others / The Importance of Health and Well-Being	SDG 3,8
403-7	Prevention and mitigation of occupational health and safety impacts	Dana 2021 Sustainability & Social Responsibility Report: Value Others / Safety First	SDG 3,8
403-8	Workers covered by an occupational health and safety management system	Dana 2021 Sustainability & Social Responsibility Report: People / Reaching ISO 45001 Certification Goal	SDG 3,8
403-9	Work-related injuries	Dana 2021 Sustainability & Social Responsibility Report: Value Others / Safety First and graphs detailing Lost Time Recordable and Recordable Incident Rates	SDG 3,8
403-10	Work-related ill health	Dana 2021 Sustainability & Social Responsibility Report: Value Others / Safety First and graphs detailing Lost Time Recordable and Recordable Incident Rates	SDG 3,8
GRI 404: Training & Education			
103-1	Explanation of the material topic and its boundary	Dana 2021 Sustainability & Social Responsibility Report: Appendix / Methodology	NA
103-2	The management approach and its components	Dana 2021 Sustainability & Social Responsibility Report: Value Others / People Development	SDG 4,8
103-3	Evaluation of the management approach	Dana 2021 Sustainability & Social Responsibility Report: Value Others / People Development	SDG 4,8
404-1	Average hours of training per year per employee	Dana 2021 Sustainability & Social Responsibility Report: Value Others / Focus on Safety Education and People Development	SDG 4,8
404-2	Programs for upgrading employee skills and transition assistance programs	Dana 2021 Sustainability & Social Responsibility Report: Value Others / People Development	SDG 4,8
404-3	Percentage of employees receiving regular performance and career development reviews	Dana 2020 Sustainability & Social Responsibility Report: Value Others / People Development	SDG 4,8

GRI 405: Diversity & Equal Opportunity			
103-1	Explanation of the material topic and its boundary	Dana 2021 Sustainability & Social Responsibility Report: Appendix / Methodology	NA
103-2	The management approach and its components	Dana 2021 Sustainability & Social Responsibility Report: Value Others / Inclusion and Diversity	SDG 5,8,10
103-3	Evaluation of the management approach	Dana 2021 Sustainability & Social Responsibility Report: Value Others / Inclusion and Diversity	SDG 5,8,10
405-1	Diversity of governance bodies and employees	Dana 2021 Sustainability & Social Responsibility Report: Value Others / Inclusion and Diversity and Employment Data <u>Board of Directors</u> <u>Dana 2022 Proxy</u> , page 41	SDG 5,8,10
405-2	Ratio of basic salary and remuneration of women to men	This information is being collected and analyzed.	SDG 5,8,10
GRI 406: Non-Discrimination			
103-1	Explanation of the material topic and its boundary	Dana 2021 Sustainability & Social Responsibility Report: Appendix / Methodology	NA
103-2	The management approach and its components	Dana 2021 Sustainability & Social Responsibility Report: Value Others / Inclusion and Diversity	SDG 5,8,10
103-3	Evaluation of the management approach	Dana 2021 Sustainability & Social Responsibility Report: Value Others / Inclusion and Diversity	SDG 5,8,10
406-1	Incidents of discrimination and corrective actions taken	Dana 2021 Sustainability & Social Responsibility Report: Culture Matters / Ethics and Compliance Helpline	SDG 5,8,10,16
GRI 414: Supplier Social Assessment			
103-1	Explanation of the material topic and its boundary	Dana 2021 Sustainability & Social Responsibility Report: Appendix / Methodology	NA
103-2	The management approach and its components	Dana 2021 Sustainability & Social Responsibility Report: Emissions Reduction / Sustainable Supply Chain	SDG 12
103-3	Evaluation of the management approach	Dana 2021 Sustainability & Social Responsibility Report: Emissions Reduction / Sustainable Supply Chain	SDG 12
414-1	New suppliers that were screened using the social criteria	Dana 2021 Sustainability & Social Responsibility Report: Emissions Reduction / Sustainable Supply Chain	SDG 12

**Material Topic: Innovation and Product Lifecycle Management**

103-1	Explanation of the material topic and its boundary	Dana 2021 Sustainability & Social Responsibility Report: Appendix / Methodology	NA
103-2	The management approach and its components	Dana 2021 Sustainability & Social Responsibility Report: Innovation	SDG 8,9,13
103-3	Evaluation of the management approach	Dana 2021 Sustainability & Social Responsibility Report: Innovation	SDG 8,9,13
Misc.	Innovation	Dana 2021 Sustainability & Social Responsibility Report: Innovation Dana 2021 10-K , pages 4 & 5 (Engineering and Research and Development) Innovation and Technology Markets e-Mobility	SDG 8,9,13
Misc.	Product Lifecycle Management	The information is being collected and will be reported at a later date.	SDG 8,9,13

SASB Index

The Sustainability Accounting Standards Board (SASB) is an independent nonprofit organization that sets standards to guide the disclosure of financially material sustainability information by companies to their investors. SASB Standards identify the subset of environmental, social, and governance (ESG) issues most relevant to financial performance.

Disclosure Number	Disclosure Name	2021 Response	SDGs
Energy Management			
TR-AP 130a.1.1	Total energy Consumption in gigajoules (GJ)	6,720,613 GJ in 2021; 7.8% decrease from 2019 and 7.5% increase from 2020 Note: Energy consumption was reduced significantly in 2020 as a result of COVID-19 and a temporary reduction in facility work schedules.	SDG 7,12,13
TR-AP 130a.1.2	Percentage of grid electricity consumed	98.4% in 2021; Reduction of 1% in grid electricity compared to 2019 and 2020 consumption of grid electricity	SDG 7,12,13
TR-AP 103a.1.3	Percentage of renewable energy consumed	1.6% in 2021; Dana has installed solar panels at several facilities, entered into an agreement with the Toledo Community Foundation to purchase electricity from a newly constructed solar array, and has signed a long-term virtual power purchase agreement with NextEra Energy generating 300,000 MWh of renewable electricity annually beginning in 2022. Dana 2021 Sustainability & Social Responsibility Report: Taking Action	SDG 7,12,13
Waste Management			
TR-AP 150a.1.1	Total amount of waste generated in metric tons (MT)	184,709 MT in 2021	SDG 12,15
TR-AP 150a.1.2	Percentage of waste generated that was hazardous	7% in 2021	SDG 12,15
TR-AP 150a.1.3	Percentage of waste generated that was recycled	76% in 2021	SDG 12,15

Product Safety			
TR-AP 250a.1.1	Total number of recalls issued	Dana had zero voluntary recalls in 2021.	SDG 9,16
TR-AP 250.a.1.2	Total number of units that were subject to a recall	Zero involuntary recalls were issued to Dana in 2021.	SDG 9,16
Design for Fuel Efficiency			
TR-AP 410a.1.1	Total revenue from products that are designed to increase fuel efficiency and/or reduce emissions during their use	Dana 2021 Annual Report page 5	SDG 8,9,13
Materials Sourcing			
TR-AP 440a.1.1	Strategic approach to managing risks associated with the use of critical materials in products	Dana does not use any of the critical materials listed in the standard. Dana has a policy and process to manage identified Conflict Minerals. Dana 2021 Sustainability & Social Responsibility Report: Culture Matters	SDG 9,10,12
TR-AP 440a.1.2	Identify the critical materials that present a significant risk to operations	Dana does not use any of the critical materials listed in the standard. Dana has a policy and process to manage identified Conflict Minerals. Dana 2021 Sustainability & Social Responsibility Report: Culture Matters	SDG 9,10,12
TR-AP 440a.1.3	Disclosure sufficient for the risk without compromising confidential information	Dana does not use any of the critical materials listed in the standard. Dana has a policy and process to manage identified Conflict Minerals. Dana 2021 Sustainability & Social Responsibility Report: Culture Matters	SDG 9,10,12

Materials Efficiency			
TR-AP 440b.1.1	Percentage of products sold, by revenue, that are recyclable	The information is being collected and will be reported at a later date.	SDG 9,12
TR-AP 440b.1.2	Percentage calculated as the revenue from products sold that are recyclable divided by the revenue from all products sold		SDG 9,12
TR-AP 440b.1.3	Limit to products that are automotive parts, components, and materials		SDG 9,12
TR-AP 440b.2.1	Percentage of input materials that are derived from recycled or remanufactured content		SDG 9,12
TR-AP 440b.2.2	Percentage calculated as the weight of input materials consumed derived from recycled or remanufactured content divided by the total weight of all input materials consumed		SDG 9,12
Competitive Behavior			
TR-AP 520a.1.1	Total amount of monetary losses incurred during the reporting period as a result of legal proceedings associated with anti-competitive behavior regulations	Dana's public filings would identify any significant monetary losses.	SDG 9,16
TR-AP 520a.1.2	Any adjudicative proceeding before a court, a regulator, an arbitrator, or otherwise	Dana's public filings would identify any significant pending proceedings.	SDG 9,16
TR-AP 520a.1.3	Losses, including any monetary liabilities to the opposing parties or others, fines and other monetary liabilities incurred during the reporting period as a result of civil actions, regulatory proceedings, and criminal actions	Dana's public filings outline its financial status including recurring and non-recurring items. Any significant losses will be identified in this information.	SDG 9,16
TR-AP 520a.1.4	Scope of monetary losses excluding legal and other fees and expenses incurred in its defense	Dana's public filings outline its financial status including recurring and non-recurring items. Any significant losses will be identified in this information.	SDG 9,16



TR-AP 520a.1.5	Scope of the disclosure, including legal proceedings associated with the enforcement of relevant regulations	Dana's public filings outline its financial status including recurring and non-recurring items. Any significant losses will be identified in this information.	SDG 9,16
TR-AP 520a.1.6	Scope of the disclosure, including legal proceedings associated with enforcement of relevant industry regulations promulgated by regional, national, state, and local regulatory authorities	Dana's public filings outline its financial status including recurring and non-recurring items. Any significant losses will be identified in this information.	SDG 9,16

TCFD Index

The Financial Stability Board established the Task Force on Climate-related Financial Disclosures (TCFD) to develop recommendations for more effective climate-related disclosures that could promote more informed investment, credit, and insurance underwriting decisions and, in turn, enable stakeholders to understand better the concentrations of carbon-related assets in the financial sector and the financial system's exposures to climate-related risks.

Recommended Disclosure	2021 Response	SDGs
Governance		
a) Describe the Board's oversight of climate-related risks and opportunities.	CDP Climate Change 2021 Report, Section C1.1 C1.1: Board committees have expanded oversight to include environmental, social and governance (ESG) issues receiving sustainability updates on all ESG issues, including climate change. On July 28, 2020, Dana Incorporated announced that its Board of Directors has established a standing Technology and Sustainability Committee focused on technological and environmental stewardship. The Technology and Sustainability Committee is responsible for assisting the Board with oversight relating to innovation, new technologies, and sustainability and social responsibility. Key areas of focus for the Committee include the strategy, implementation, and effectiveness of Dana's research and development initiatives, emerging trends in science, technology, and related regulations, strategic approach to technical talent management, and sustainability and social responsibility activities. More information can be found at: https://www.dana.com/newsroom/press-releases/dana-incorporated-board-of-directors-establishes-technology-and-sustainability-committee/	SDG 7,12,13
b) Describe management's role in assessing and managing climate-related risks and opportunities.	CDP Climate Change 2021 Report, Section C1.2 Sustainability & Social Responsibility Governance	SDG 7,12,13

Strategy		
a) Describe the climate-related risks and opportunities the organization has identified over the short, medium, and long term.	CDP Climate Change 2021 Report, Section C2.3, C2.4, C2.5 and C2.6	SDG 7,12,13
b) Describe the impact of climate-related risks and opportunities on the organization's businesses, strategy, and financial planning.	CDP Climate Change 2021 Report, Section C2.3, C2.4, C2.5 and C2.6	SDG 7,12,13
c) Describe the resilience of the organization's strategy, taking into consideration different climate-related scenarios, including 2°C or lower scenario.	This information will be included in the 2022 CDP submission.	SDG 7,12,13
Risk Management		
a) Describe the organization's processes for identifying and assessing climate-related risks.	CDP Climate Change 2021 Report, Section C2.2b	SDG 7,12,13
b) Describe the organization's processes for managing climate-related risks.	CDP Climate Change 2021 Report, Section C2.2d	SDG 7,12,13
c) Describe how processes for identifying, assessing, and managing climate-related risks are integrated into the organization's overall risk management.	CDP Climate Change 2021 Report, Section C2.2c	SDG 7,12,13
Metrics and Targets		
a) Disclose the metrics used by the organization to assess climate-related risks and opportunities in line with its strategy and risk management process.	CDP Climate Change 2021 Report, Section C4.1	SDG 7,12,13

<p>b) Disclose Scope 1, Scope 2, and if appropriate, Scope 3 greenhouse gas (GHG) emissions, and the related risks.</p>	<p>Dana 2021 Sustainability & Social Responsibility Report: Taking Action</p> <p>Scope 1 GHG Emissions (kg CO₂-e): 2019: 162,407,000 kg 2020: 133,223,000 kg 2021: 145,236,000 kg</p> <p>2021 Scope 1 Energy Consumption by Type (MWh): Natural Gas: 694,359 MWh LPG: 52,772 MWh Diesel: 10,596 MWh Gasoline: 1,111 MWh</p> <p>Scope 2 GHG Emissions (kg CO₂-e) 2019: 455,435,000 kg 2020: 388,347,000 kg 2021: 401,322,000 kg</p> <p>2021 Scope 2 Energy Consumption by Type (MWh) Grid Electricity: 1,090,789 MWh Renewable Electricity: 17,210 MWh</p>	SDG 7,12,13
<p>c) Describe the targets used by the organization to manage climate-related risks and opportunities and performance against targets.</p>	CDP Climate Change 2021 Report, Section C4.1	SDG 7,12,13
<p>Transportation Group Metrics</p>		
<p>a) Revenues/savings from investments in low-carbon alternatives (e.g. R&D, equipment, products or services)</p>	This information will be included in the 2022 CDP submission.	SDG 7,12,13



People Finding A Better Way[®]