



Better World™

2023 Sustainability and Social Responsibility Report

Contents

Chairman and CEO Message

Overview

About Dana
Climate Action

Value Others

Safety First
Diversity, Equity, and Inclusion
People Development

Innovation

Technology
Global Technology Centers
Quality Signature

Taking Action

Sustainability in Action
Supply Chain

One Community

Projects Around the World

Culture Matters

Leadership
Ethics and Integrity
Cybersecurity Spotlight

Appendix

Methodology
UN Sustainable Development Goals
Global Reporting Initiative



Chairman and CEO Message



James Kamsickas, Dana Chairman and CEO

A keynote speaker at the Advanced Clean Energy Transportation (ACT) Expo
May 2, 2023, Anaheim, California, United States

Dear Stakeholders,

Dana has been transforming the mobility industry since its founding in 1904.

Longevity in this business — 120 years and counting — comes from passion, purpose, and persistence.

Qualities that have shaped our leadership position in e-Propulsion technologies and our approach to tackling climate change through meaningful and lasting action.

Addressing the most significant challenge of our time means setting ambitious climate goals as Dana has done.

Committing to be net zero by 2040 and accelerating the reduction of Scope 1 and 2 greenhouse gas (GHG) emissions with plans to achieve a more than 75% decrease by 2030.

It's also about transparently measuring, validating, and reporting on targets using a science-based approach. Following validation of our climate commitments by the Science Based Target initiative (SBTi), Dana initiated a revised validation process for our 2040 net zero target and other climate actions.

Our partnership with SBTi helps to drive sustainable best practices and lead the way to a zero-carbon economy.

Dana's annual reporting to the Carbon Disclosure Project further supports the important mission to collect, measure, and reduce global GHG emissions.

Changing Our World Through e-Propulsion

Over this past year, we have not only continued our growth trajectory — with record sales and program launches across a balanced product portfolio — but strategically partnered with our customers at varying phases in their electrification journeys.

Currently, 74% of Dana's three-year new business backlog comes from innovating next-generation clean-energy technologies.

These capabilities are powered by Dana's in-house advantage in electrification delivering complete, fully integrated electrified systems for all mobility markets with gearbox, low- to high-voltage motor, inverter, controls, and thermal management expertise.

A pipeline of innovative thinking is supported across a global network of Dana Technology Centers which are home to some of the world's most creative minds. Our technologies have been recognized with nine *Automotive News* PACE Awards — heralding the industry's game-changing innovations — and been a finalist on 25 occasions.

It's a mindset of embracing change. Of questioning and being curious. Of a proactive approach to partnering with customers. We recognize the privilege of enhancing their most iconic and technologically advanced vehicles and the weight of responsibility entrusted to us.

"Dana's in-house electrification advantage powers complete, fully integrated electrified systems across all mobility markets."

From the introduction of Dana's electrified drivetrain offerings supporting the construction industry; to a new 8-speed, dual-clutch hybrid transmission for the super sports cars segment; to our metallic bipolar plates engineered to optimize performance and advance the commercialization of hydrogen fuel for mobility and industrial power conveyance applications — 2023 was a benchmark year.

We will continue to deliver leading-edge power management innovations to champion our customers' clean energy priorities anywhere in the world.

Setting the Standard

Within the mobility industry, we have a unique opportunity to lead by example, not only in designing and developing technologies but in how we manufacture to reduce our impact on the environment.

We progress hundreds of global efficiency projects annually across Dana and incorporate ESG data into our global supplier sourcing strategies. ESG data comprises a significant portion of our scorecard which we use to assess and select our suppliers.



In 2023, we were selected to support fully integrated e-Propulsion systems for all-new EV programs for global vehicle manufactures across all end markets.

We have been advancing our environmental management systems and have certified all of Dana's major manufacturing sites to International Organization for Standardization (ISO) 14001:2015.

This ISO internationally recognized standard sets out the requirements for an environmental management system, helping organizations continually improve their environmental performance through efficient use of resources, reduction of waste, and regulatory compliance.

We have also been actioning renewable energy. In 2023, our dedicated United States wind facility generated 324,637 megawatt hours of renewable electricity representing a 99.8% offset of Dana's Scope 2 emissions from purchased electricity in the United States and Canada.

Scheduled to commence operations in January 2025, our dedicated European solar facility will supply Dana with approximately 240,000 megawatt hours per year of renewable energy, targeting a 100% offset of Dana's Scope 2 emissions from purchased electricity in Europe.

We will keep pursuing these and other impactful solutions to reduce our carbon footprint and protect our shared planet.

One Dana, Everywhere

As we power the vehicles and machines that move our world, we value others. We treat people with respect and integrity.

Recent recognition include being named a 'World's Most Ethical Company 2024' by Ethisphere, one of 'America's Most Responsible Companies 2024' by Newsweek, and 'Top Employer 2024' in most of countries in which we operate by the Top Employer Institute.

At Dana, we value creativity and place a focus on customer success that underscores everything we do. Multiple customer awards from Caterpillar, Daimler, Ford, General Motors, Idealease, JLR, John Deere, PACCAR, Sany, Tata, Toyota, Volkswagen, AB Volvo, among others completed the picture in 2023.

It all adds up.

I couldn't be prouder of our 42,000 people in over 30 countries who power innovation to move our world. And I am profoundly thankful for their work.

We have hurdled barriers that once seemed impossible to clear. We embrace the journey together as 'One Dana' with dedication to each other, to our customers, to our communities, and to our planet.

My personal best,

James K. Kamsickas
Chairman and Chief Executive Officer

ABOUT DANA

By the Numbers

1904

history dating
back 120 years

88

major
manufacturing facilities

11k+

patents

\$10.6B

2023 Sales

10

country network of
technology centers

31

countries with
Dana presence

42k

employees globally

13k+

customers in 141 countries

6

continents

BUSINESS UNITS

Commercial Vehicle Drive and Motion Systems

Dana is an industry leader in the supply of traditional and electrified systems for medium-and heavy-duty commercial vehicles. We help original-equipment manufacturers and end-market customers achieve the best weight, performance, and efficiency, as well as the lowest cost of ownership, no matter the powertrain configuration.

Light Vehicle Drive Systems

Dana is a leading supplier of fully integrated drivetrain and electrified propulsion systems for all passenger vehicles. Working collaboratively with original-equipment manufacturers and the aftermarket, we focus on delivering best-in-class efficiency, maximum durability, and superior ride and handling across the globe.

Off-Highway Drive and Motion Systems

Dana delivers mobile drivetrain and motion solutions for construction, agriculture, material handling, and mining equipment, as well as motion systems for a wide variety of mobile and stationary industrial applications. These customized solutions support vehicles and machines with both conventional and electrified power sources and are designed to deliver innovative technologies that serve customers worldwide.

Power Technologies

Dana provides advanced thermal-management and sealing solutions to all end markets in support of conventional, electrified, and fuel-cell platforms. Leveraging the most cutting-edge technology and manufacturing processes, we deliver custom-engineered solutions designed to optimize efficiency and performance.

ABOUT DANA

2023 Sales

By Region

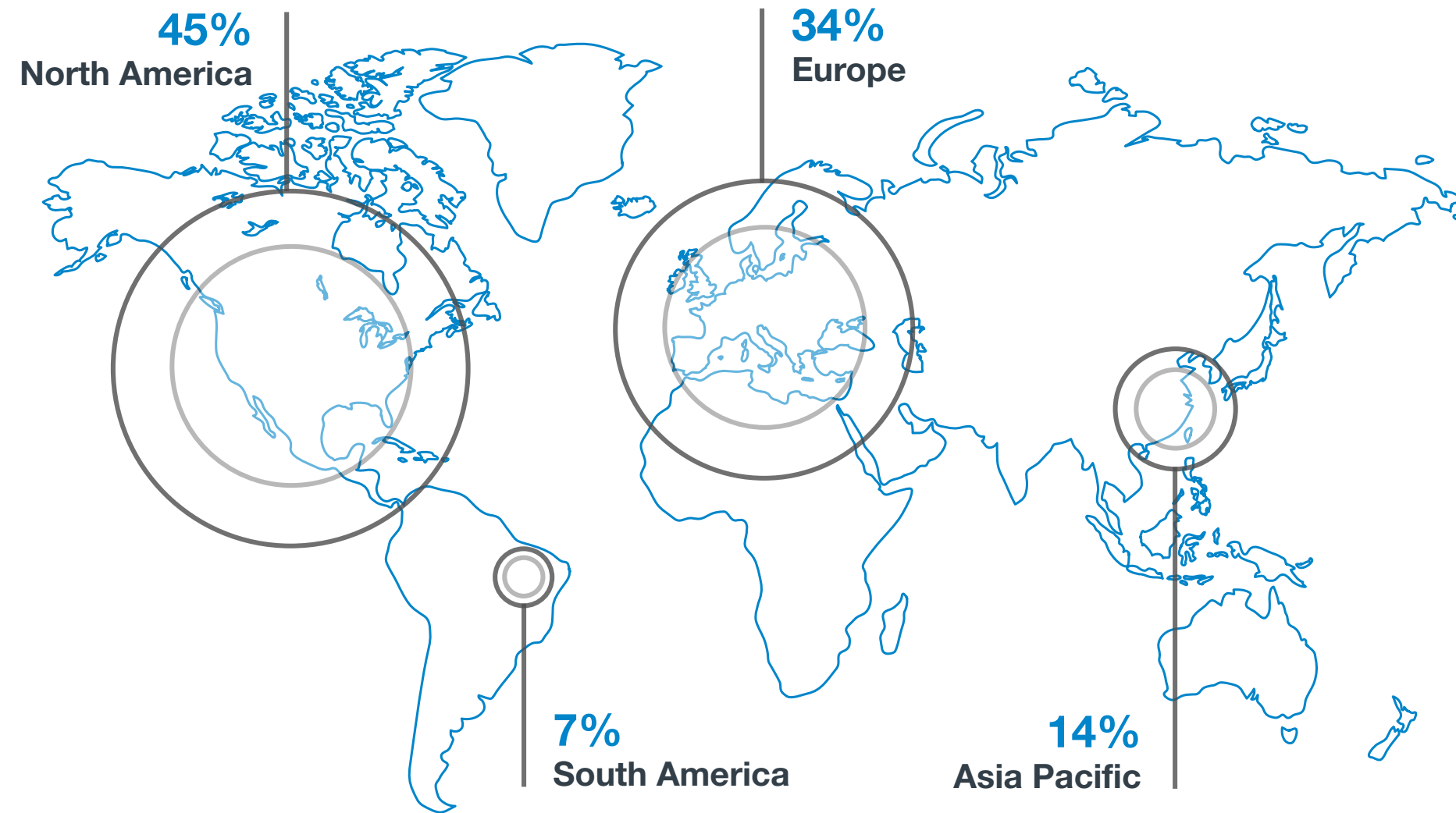

Sales as of Dec. 31, 2023. Consolidated sales only.

By Customer

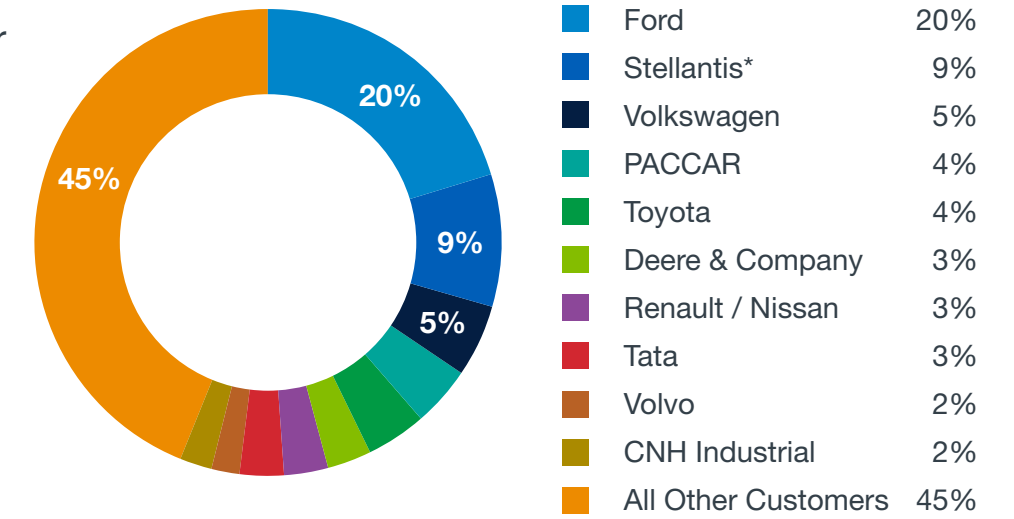

* Includes sales to system integrators for driveline products that support Stellantis vehicles.

By Segment

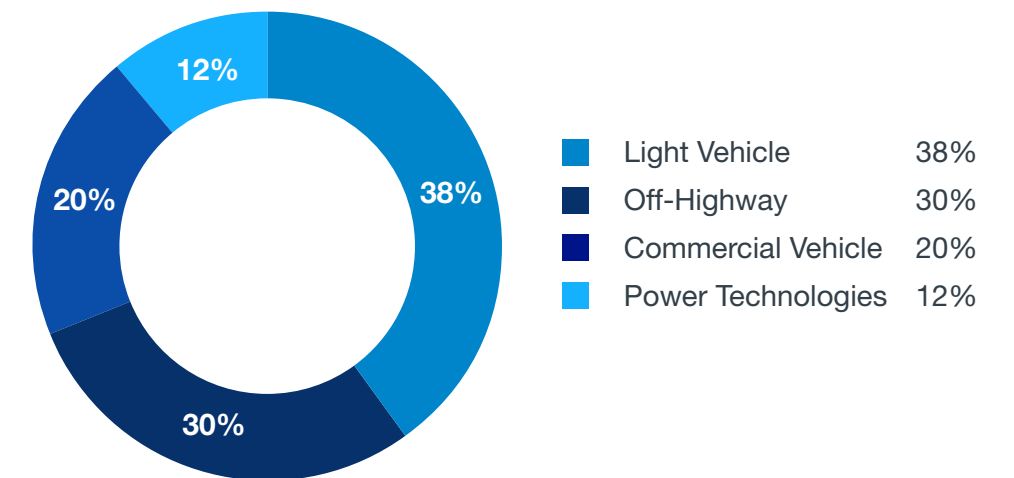

By Market

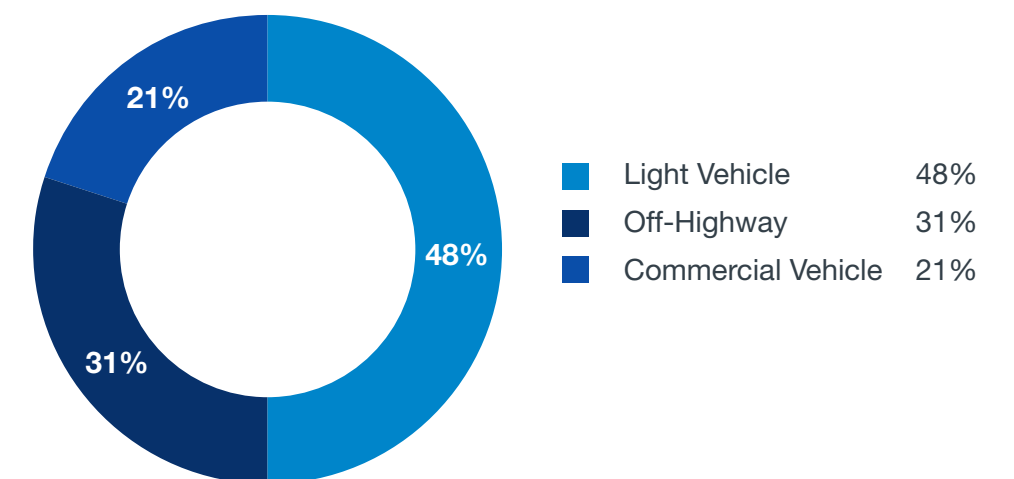

ABOUT DANA

Employment Data

[View our diversity disclosure and EEO-1 data](#)

By Gender

Employees by Employment Type and Gender

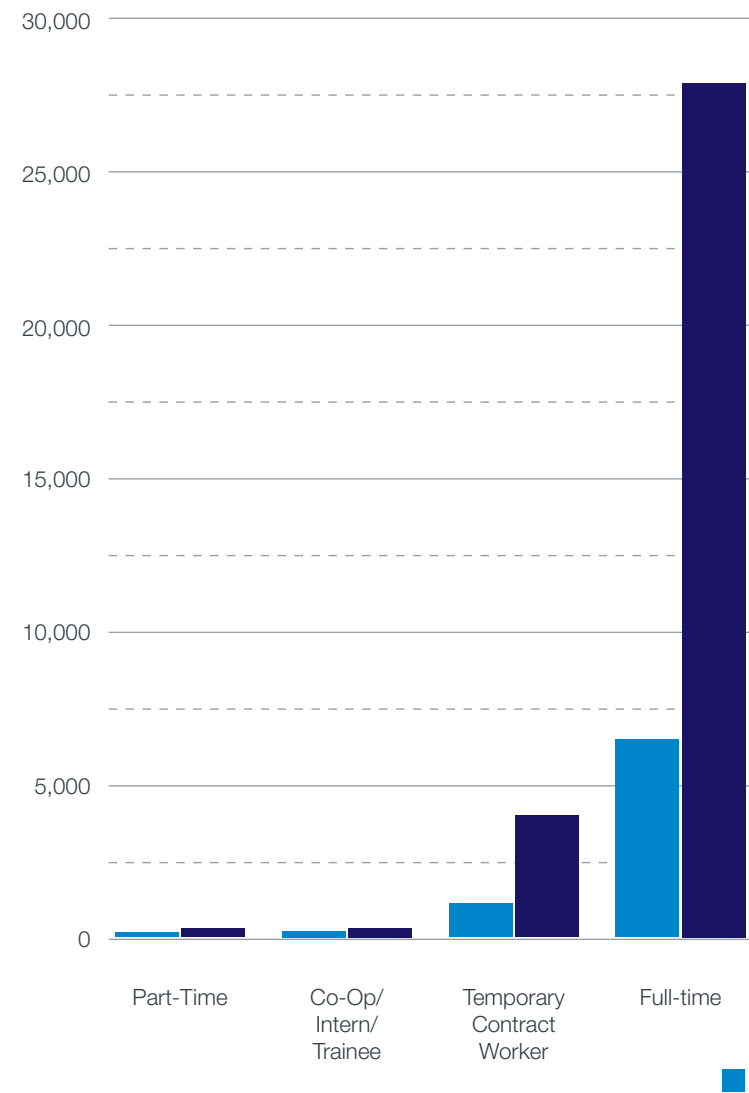

Employees¹

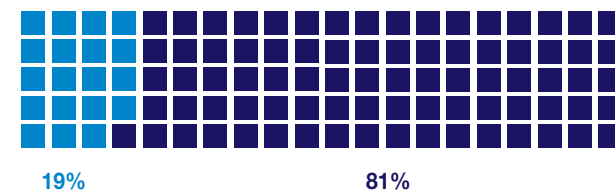

New Hires

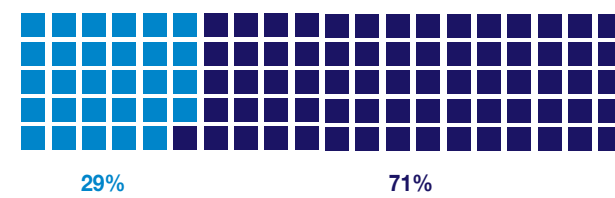

Attrition

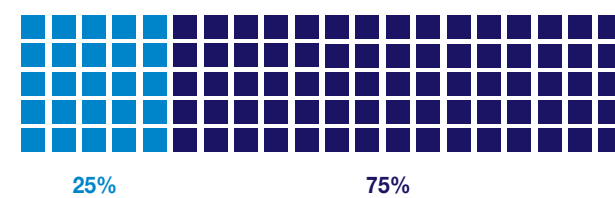

By Region

Employees¹

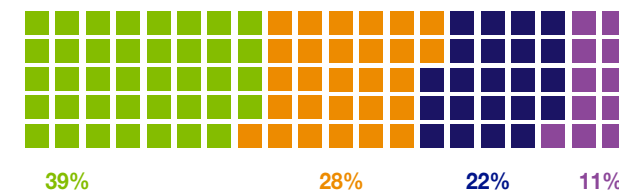

New Hires

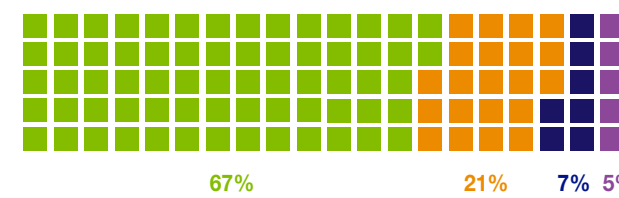

Attrition

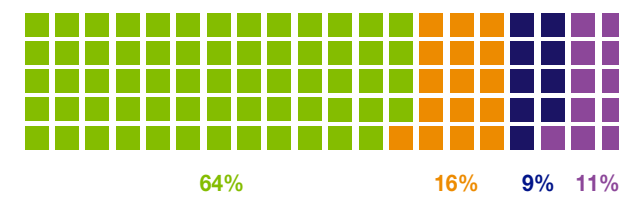

■ North America ■ Asia Pacific
■ Europe ■ South America

By Age

Employees²

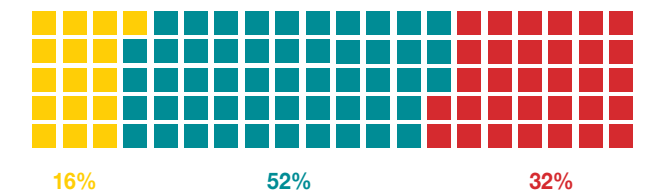

New Hires²

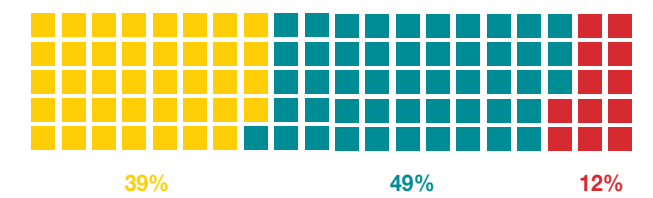

Attrition²

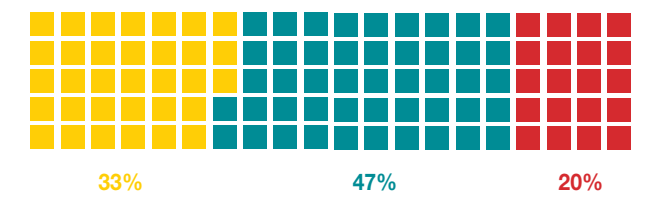

■ Under 30 ■ 30 - 50 ■ Over 50

¹ Per headcount policy, vendor service workers, JV unconsolidated, employees on unpaid leave or layoff are excluded from headcount

² Date of birth is not available for certain types of employment classifications (e.g., contractors) and therefore in these instances age is unknown or not provided

ABOUT DANA

Awards

Newsweek Names Dana One of “America’s Most Responsible Companies” for Fifth Consecutive Year

Once again, Dana was named to *Newsweek* magazine’s “America’s Most Responsible Companies,” marking the fifth consecutive year for this honor.

Based on a detailed analysis by *Newsweek* and its partner, Statista, the listing reviews the corporate social responsibility efforts of the 2,000 largest public companies by revenue — including each company’s business practices in environmental, social, and corporate governance categories.

Additionally, Dana was named as one of “America’s Greatest Workplaces for Diversity” for the second consecutive year, recognizing our impact and commitment to building a culture that supports and embraces diversity.

Finally, *Newsweek* named Dana one of “America’s Greatest Workplaces for Women,” marking the second consecutive year for this distinction and one of only two tier-one mobility suppliers among 600 companies identified in the rankings.



Dana Named “Top Employer 2024” in 16 Countries, Regional Distinction for Europe and North America

Dana has been honored by the Top Employers Institute as a “Top Employer 2024” across 16 countries worldwide. This prestigious accolade celebrates Dana’s commitment to exceptional human resources practices, including diversity and inclusion, work environment, talent acquisition, learning, and employee wellbeing.

Brazil, Canada, Mexico, and Spain joined the 12 countries listed last year as a Top Employer including Belgium, China, Germany, Hungary, India, Italy, Lithuania, the Netherlands, Sweden, Switzerland, United Kingdom, and United States.

These Dana operations have demonstrated their dedication to fostering an empowering environment for employees through people-centric practices. The additions of Canada and Mexico meant that Dana secured the title of Top Employer for the North America region in addition to our European region recognition.

This distinction underscores Dana’s unwavering commitment to creating workplaces where talent thrives and diversity flourishes.

[Read more about these awards.](#)



Dana Recognized as One of World's Most Ethical Companies for Second Consecutive Year

Ethisphere, a global leader in defining and advancing the standards of ethical business practices, recognized Dana as one of the 2024 World's Most Ethical Companies®.

Our commitment to excellence begins with doing business the right way — every day. This prestigious honor celebrates the “One Dana” mindset and our collective efforts to ensure that everyone is valued and treated with respect and that business is always conducted responsibly and ethically.

The World's Most Ethical Companies assessment comprises an extensive questionnaire of over 240 different proof points on companies' culture of ethics; environmental, social, and governance practices; ethics and compliance program; diversity, equity, and inclusion; and initiatives that support a strong value chain.

In 2024, a total of 136 companies spanning 20 countries and 44 industries were recognized. Dana is one of only eight honorees across the mobility industry.

[Read more about this award.](#)

CLIMATE ACTION

75%+

Reduction of
Scope 1
and Scope 2
GHG
emissions
by 2030

25%+

Reduction in
Scope 3
GHG
emissions
by 2030

2040

Net zero



SCIENCE
BASED
TARGETS

DRIVING AMBITIOUS CORPORATE CLIMATE ACTION

Managing
with Science
Based
Targets

CLIMATE ACTION



Better World™

Global Energy Emissions Impact 2019-2023

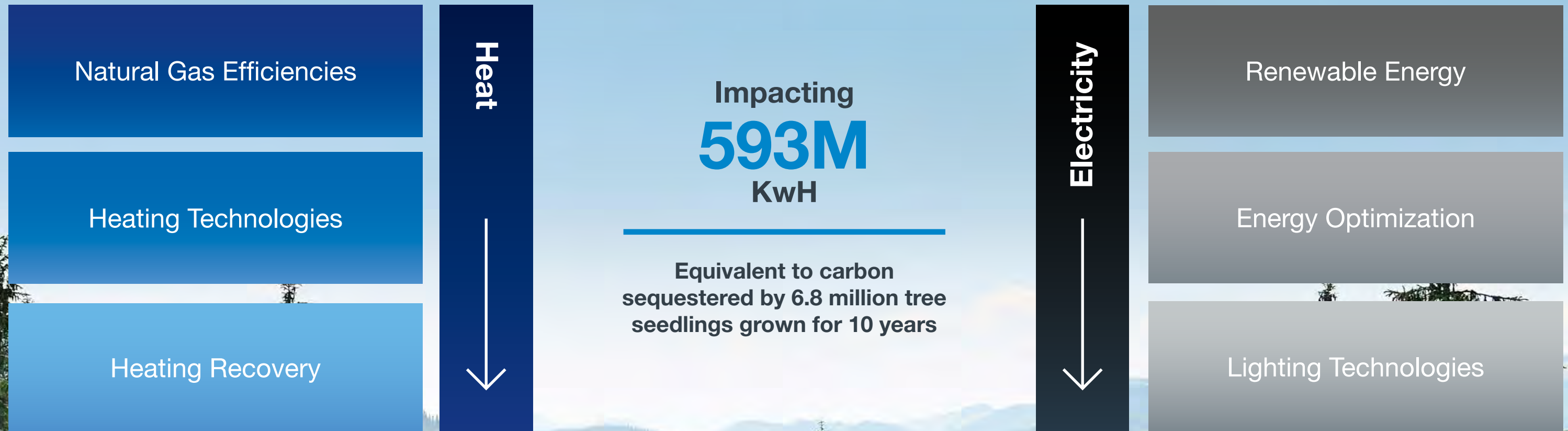

CLIMATE ACTION

Acting **NOW** to Protect Our Shared Planet

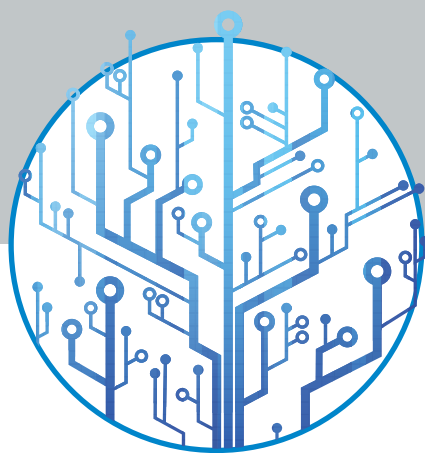

Changing Our World Through e-Propulsion

Powering a zero-emissions future with our in-house advantage in electrification.

74% of Dana's three-year new business backlog comes from innovating next-generation clean-energy technologies including efficient e-propulsion systems, electrodynamic products, thermal management technologies, and metallic bipolar plates for fuel cell applications.



Actioning Renewable Energy

Advancing on-site and off-site renewable energy generation technologies globally.

Examples include targeting a 100% offset of Dana's Scope 2 emissions in the United States and Canada. From 2025, we will aim to offset 100% of Dana's Scope 2 emissions in Europe.



Greening Our Operations

Advancing environmental management systems with 100% of Dana's major manufacturing sites now ISO 14001:2015 certified.

Promoting ISO 50001:2018 energy management certification globally and recognition as green buildings for new facilities.



Driving a Responsible Supply Chain

Incorporating ESG data into our global supplier sourcing strategies. ESG data comprises a significant portion of our scorecard which we use to assess and select our suppliers.

Collecting supplier GHG emissions, reduction plans, and product lifecycle reviews. Developing sustainable alternatives through global commodity strategies.

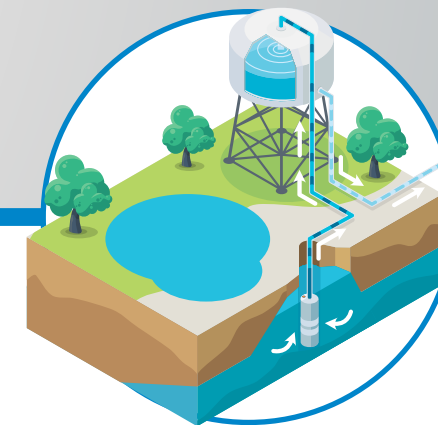

Protecting Water Resources

Progressing hundreds of global efficiency projects each year across Dana.

Including water reduction and reuse programs, rainwater harvesting, and working with communities to advance the biodiversity of rural and urban areas by promoting clean water and conserving ecosystems.



Financing and Manufacturing Sustainably

Driving the transition to a low-carbon economy, utilizing a \$400M green bond to finance investments in electrification.

Advancing climate action including a net zero 2040 GHG emissions target with validation by the Science Based Targets initiative.



Better World™

CLIMATE ACTION

North American Windfarm:

**Generated renewable electricity
offsetting 99.8% of Dana's Scope 2
emissions in the United States
and Canada in 2023**



CLIMATE ACTION

European Solar Farm:

Targeting 100% offset of Dana's Scope 2 emissions in Europe

Commencing 2025



CLIMATE ACTION

Dana to reduce annual greenhouse gas emissions by more than 75% by 2030



Scope 1

From Operations

Sustainable Mobility Center



Improving operational efficiencies and reducing on-site fuel consumption

(including natural gas, propane, diesel, gasoline)

Transitioning to electric vehicles

(including company vehicles, forklifts)

Installing on-site EV chargers

(including supporting transition to clean energy)

Improving building energy efficiency to reduce on-site fuel consumption

(including insulation, temperature automation, and capture / re-use of waste heat)

Scope 2

From Purchased Electricity

Continuing to lock-in operation efficiency improvements and reduce electricity consumption

(including equipment auto hibernation, compressed air system efficiencies, energy-efficient HVAC systems, energy-efficient lighting)

Installing on-site renewable energy generation technologies

(solar arrays)

Leveraging off-site wind and / or solar power generation via power purchase agreements

(including adding a targeted 300,000 MWh to the United States power grid)

Scope 3

From Other Indirect Emissions

Delivering new clean energy technologies and products

(including e-Propulsion systems, battery cooling, fuel cells, light-weighting, fuel efficiency)

Evaluating suppliers to drive improvements across supply chain

(including selection and monitoring process, performance scorecards)

Driving inbound and outbound transportation efficiencies

(including raw materials, components, and finished products)

Leveraging virtual communication tools to optimize travel

(including smart work practices reducing carbon footprint)

Drive Customer Centricity

1

2

CLIMATE ACTION

Progress Toward Net-Zero Emissions

It is essential to accurately measure and report on our climate commitments.

This means setting specific targets and goals for reducing greenhouse gas emissions and then tracking progress using transparent and reliable methods.

By doing so, we hold ourselves accountable and demonstrate our commitment to climate action.

Total Greenhouse Gas Emissions
(kg CO₂-e)

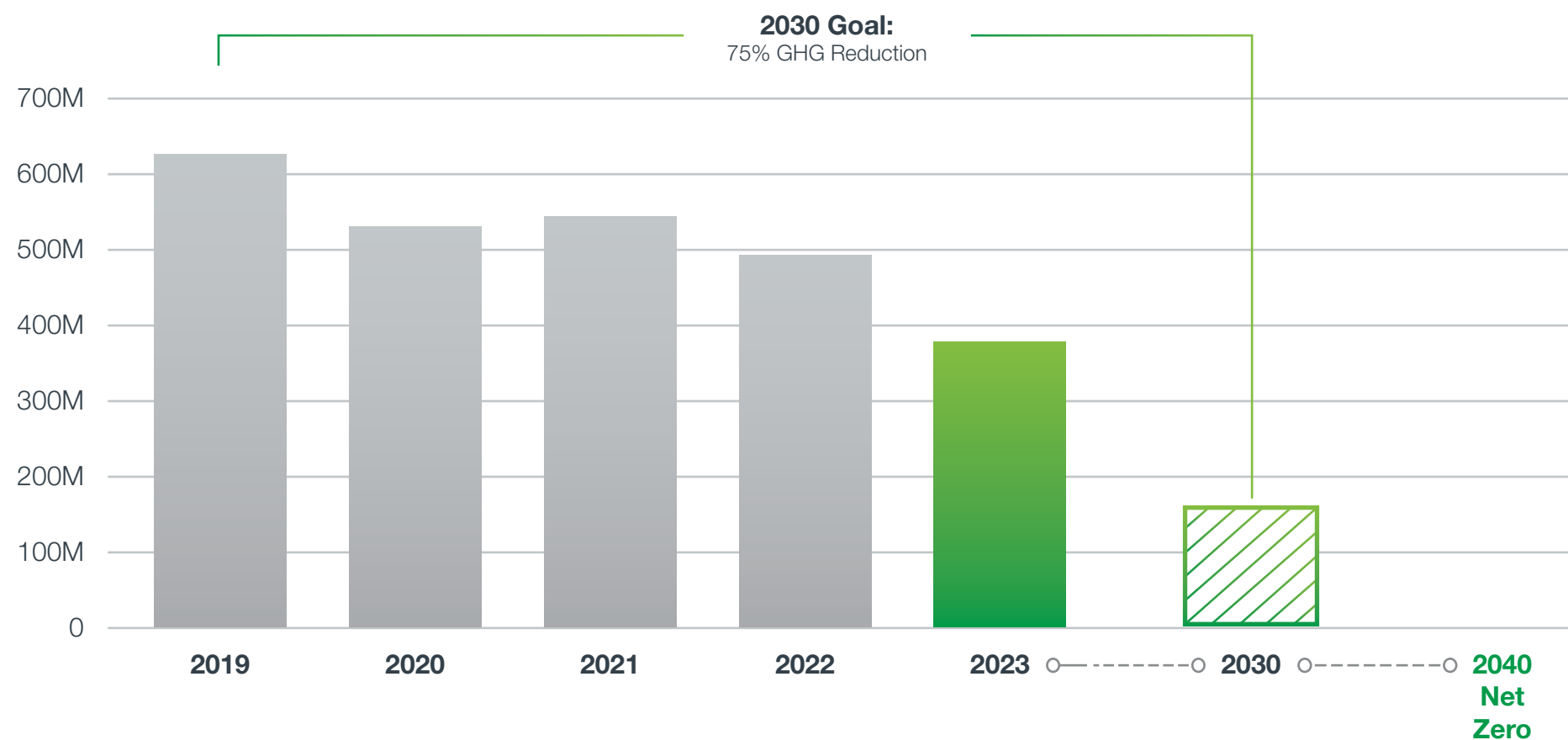

EMPLOYEE SPOTLIGHT

“I’m proud to contribute to the establishment of our state-of-the-art Åmål facility in Sweden. It operates entirely on renewable energy and delivers clean-energy technologies and fully integrated e-Propulsion systems across all end markets. A powerful combination.”

Sanne Nilsson Guerra
Shift Leader
Sweden



We value others.
That's powerful.



SAFETY FIRST

In the dynamic world of mobility manufacturing, safety isn't just a priority — it's a fundamental commitment.

As Dana advances leading-edge technologies and streamlines processes, ensuring the wellbeing of our workforce is ingrained in our culture. This means "Safety First — All Day, Every Day."

These values, beliefs, and behaviors are driven by a strong commitment across Dana leadership, employee involvement, training and education, and continual improvement.

This 'Safety First' approach requires a daily, focused effort. From the facility floor to the boardroom, every individual understands their role in fostering a safe and secure environment.

This touches on what we do and how we do it. All stakeholders — both internal and external — have a role to play. Powered by identification and control methodology, it's a shared mindset that drives our continuous improvement efforts.



Dana Global Recordable Incident Rate

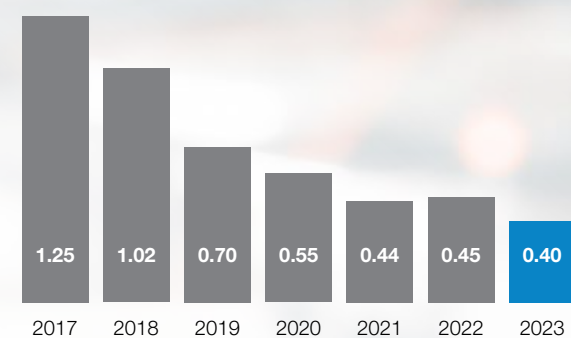

Dana Global Lost Time Recordable Incident Rate

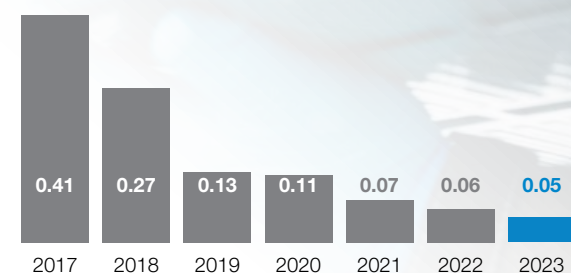

EMPLOYEE SPOTLIGHT

"Whether it's working to ensure the safety of our team, building quality into everything we do, or advancing workflow processes — we're all powering innovation to move our world."

Anil Shewale
Deputy Manager
India



100% Certified

Setting safety management system goals is critical for achieving safety objectives, holding individuals and teams accountable, and enhancing safety culture.

100% of Dana's major manufacturing facilities have achieved ISO 45001:2018 certification — the world's first international occupational health and safety management standard.

This process establishes an occupational health and safety management system regularly audited by third party registrars across the globe. It also facilitates internal improvements and provides third-party validation of our focus on the safety and wellbeing of our people.

Dana is committed to maintaining this registration for all certified facilities and complying with audited occupational health and safety management system requirements.

Regarding environmental management systems, 100% of Dana's major manufacturing facilities are also ISO 14001:2015 certified.

Looking ahead, four new operations are expected to achieve ISO 14001 and 45001 certifications in 2024. We also plan to obtain both certifications for all new major manufacturing sites within two years of operations commencement.



SAFETY FIRST

Education Drive: Environment and Occupational Health, Safety, and Security

Around the world, our people understand workplace risks and how to identify, report, and control them. To this end, Dana makes safety education a top priority and an integral part of all new employee orientation programs.

Our training is tailored to be impactful, emphasizing a culture of open, honest communication where people feel comfortable discussing concerns and making suggestions.

We also spotlight the important role of people managers across Dana — emphasizing their responsibilities and the procedures for responding to employee reports of injuries, illnesses, and incidents.

Win Together

Safety is a shared responsibility.

Our education and training program focuses on how to report potential concerns, injuries, illnesses, and incidents.

Special attention is given to:

- Prioritizing the importance of open and transparent communications in health and safety management processes.
- A thorough review of all applicable company safety rules, policies, and procedures — particularly Dana's Life Safety Rules as well as those relevant to each work area.
- Understanding and utilizing the safety hierarchy of controls, a systematic approach that ensures that the most effective control measures are executed to protect our people.
- Additional training as necessary around changes in facilities, equipment, processes, materials, or work organization whenever new tasks are undertaken.



Safety Certified

The Dana Safety Certified training program continually elevates the collective safety knowledge of our people. During 2023, more than 52,000 safety training programs were successfully completed.

Specifically focused on Environment and Occupational Health, Safety, and Security topics, the program is rolled out across four levels. With each of these levels — Safety 101, Silver, Gold, and Diamond — adding training requirements and skills.

Safety 101 is our comprehensive foundational course focused on safety culture, safe behaviors, our 'Life Safety Rules,' individual roles in safety, and key resources to advance a safe work environment.

Silver courses spotlight our Life Safety Rules with Gold courses dedicated to additional life safety critical topics. Diamond courses are focused on advanced safety, health, security, and environmental themes — including behavioral safety, environmental awareness, job safety analysis, and office safety among others.

However, our journey doesn't end here. We recognize that the landscape of workplace safety is ever-evolving, and we remain steadfast in our commitment to staying ahead of the curve.

Whether it's leveraging emerging training opportunities or collaborating with industry peers, we are dedicated to exploring new avenues for enhancing safety in everything we do.

SAFETY FIRST

1 Million+ Hours

Without a Lost-Time Incident in 2023

North And South America

In 2023, 22 major manufacturing locations in North and South America achieved significant milestones for working safely.



1 Million+ Hours

- Auburn Hills, United States
- Fort Wayne, United States
- Henderson, United States
- Humboldt, United States
- Sterling, United States
- Tlalnepantla, Mexico*

2 Million+ Hours

- Cambridge, Canada
- Danville, United States
- Gordonsville, United States
- Oakville, Canada
- Pottstown, United States

3 Million+ Hours

- Columbia, United States
- Lafayette, United States
- Warren, United States

4 Million+ Hours

- Apodaca, Mexico
- Louisville, United States
- Mount Forest, Canada

5 Million+ Hours

- Grand Bourg, Argentina
- Gravataí, Brazil*
- Paris, United States
- Querétaro, Mexico*
- Toluca, Mexico

* Indicates instances where there is more than one Dana major manufacturing facility in a particular city. Data represents hours worked without a lost-time incident recorded at a major manufacturing facility as of December 31, 2023

SAFETY FIRST

1 Million+ Hours

Without a Lost-Time Incident in 2023

Europe, Africa and Asia

In 2023, 26 major manufacturing locations in Europe, Africa and Asia achieved significant milestones for working safely.



1 Million+ Hours

- Åmål, Sweden
- Chakan, India
- Essen, Germany
- Itziar-Deba, Spain
- Luserna, Italy
- Pamplona, Spain
- Rayong, Thailand
- Rudrapur, India
- Wuxi, China
- Yancheng, China
- Zaragoza, Spain

2 Million+ Hours

- Guiscard, France
- Győr, Hungary*
- Pune, India
- Weifang, China

3 Million+ Hours

- Birmingham, United Kingdom
- Chennai, India
- Pantnagar, India
- Uitenhage, South Africa

4 Million+ Hours

- Belgaum, India
- Satara, India

5 Million+ Hours

- Fuzhou, China
- Ladkrabang, Thailand
- Neu-Ulm, Germany
- Jodalli, India

10 Million+ Hours

- Noida, India

* Indicates instances where there is more than one Dana major manufacturing facility in a particular city.
Data represents hours worked without a lost-time incident recorded at a major manufacturing facility as of December 31, 2023

DIVERSITY, EQUITY, AND INCLUSION

Leading With Diversity, Equity, and Inclusion

At Dana, we foster a culture that values and embraces our diverse strengths, nurturing a robust and inclusive culture that empowers all our people with opportunities to thrive.

Our culture and values not only draw exceptional talent with industry expertise but also cultivate curiosity and innovation among all 42,000 employees across 88 major facilities in 31 countries.

Inclusive and Equitable

We are dedicated to ensuring safe, respectful, and inclusive workplaces where everyone can contribute.

We commit to providing fair and equitable opportunities based on employees' individual talents and to facilitating the resources people need so that they can access developmental opportunities.

While diversity refers to the qualities that make people unique, inclusion refers to the Dana behaviors that ensure people feel welcome.

We recognize that people are different, and we respect those differences — including age, gender, ethnicity, religion, disability, sexual orientation, education, national origin, and other dimensions of diversity that are not as readily apparent.

As a global organization we care about the unique characteristics of our workforce by tailoring policies to diverse cultural needs — offering inclusive benefits, providing resources for cross-cultural understanding, and attracting and developing teams that reflect the communities in which we operate.

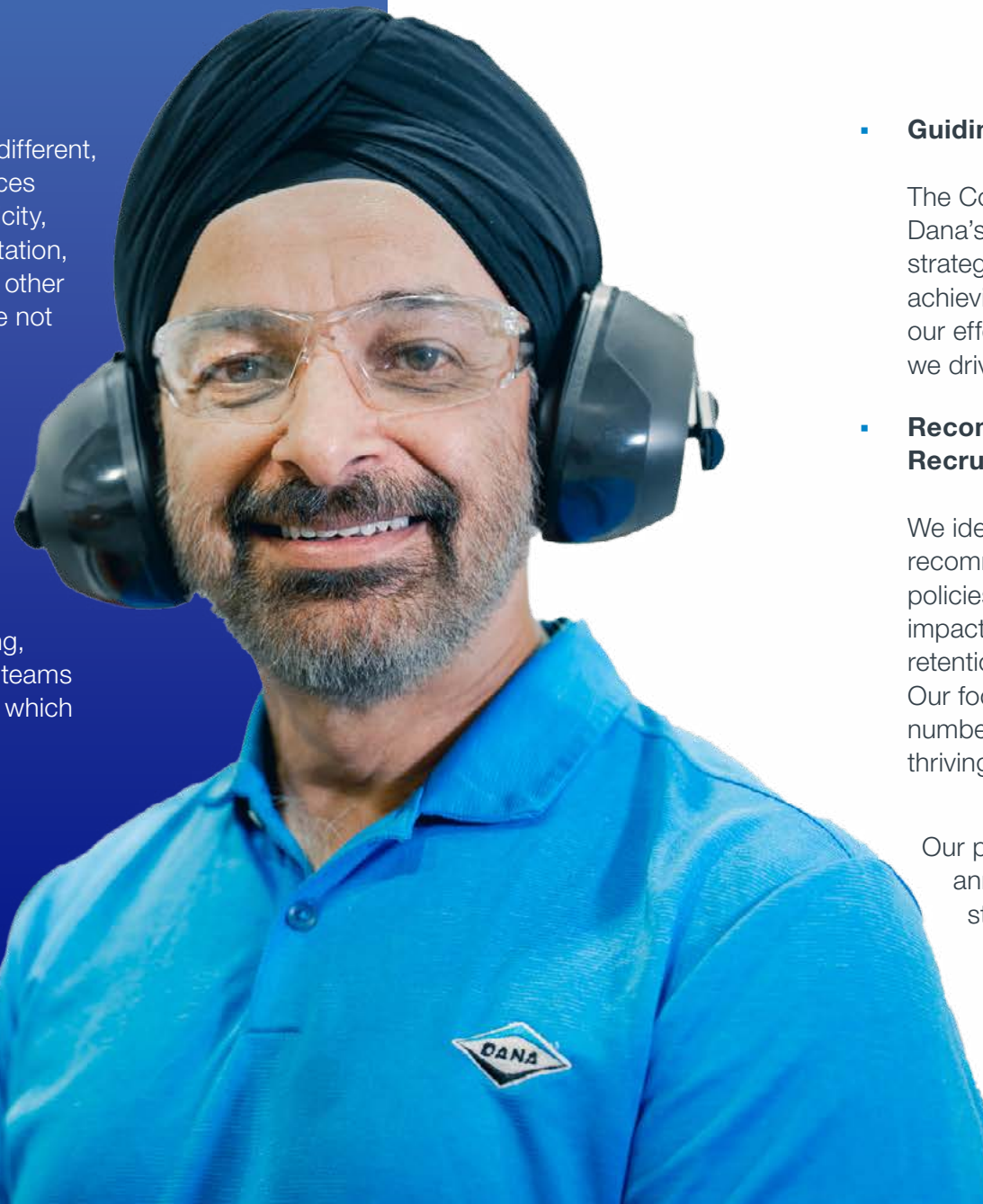

Diversity, Equity, and Inclusion Governance Committee

Dana's Diversity, Equity, and Inclusion Governance Committee operates around the world to enhance our workplace. Our committee's goals and objectives include the following:

- Guiding Dana Leadership**
 The Committee actively assists Dana's leadership in shaping diversity strategies, defining goals, and achieving key milestones. By aligning our efforts with organizational vision, we drive meaningful change.
- Transparent Access to Opportunities**
 We champion transparent processes that provide access to developmental and advancement opportunities. By prioritizing feedback mechanisms and cultural sensitivity training, we nurture an environment where every employee can thrive.
- Recommendations for Recruitment and Retention**
 We identify and formulate recommendations for programs, policies, and work practices that impact the recruitment and retention of our diverse workforce. Our focus extends beyond mere numbers; we aim for an inclusive and thriving environment.
- Advocacy for Diversity, Equity, and Inclusion**
 As stewards of Dana's diversity, equity, and inclusion strategy, we actively advocate for its implementation. Our commitment extends beyond words — we drive action.

Our progress is diligently reported to Dana's Board of Directors at least five times annually. Through collaboration and purposeful initiatives, we pave the way for a stronger, more inclusive Dana.

DIVERSITY, EQUITY, AND INCLUSION

Pillars of Strength

Dana's diversity, equity, and inclusion strategy is guided by five pillars: Leadership Commitment; Diversity Representation; Awareness, Education, and Development; Employee and Community Growth; and Cross-functional Collaboration.

Commitment and Representation

We work towards building internal and external talent pipelines and expanding our diversity recruitment, retention, and promotion efforts to increase varied representation. In our recruiting efforts, we build a workforce that reflects the communities we serve.

This incorporates transparent, data-driven talent practices and decisions to help mitigate bias and equip our leaders with the tools, information, and support necessary to achieve their objectives.

Education

We are continuously learning with a strong focus on diversity, equity, and inclusion education for all employees to ensure that we have the cultural awareness and understanding necessary to successfully build and retain diverse and inclusive teams.

We connect with third-party organizations such as the Center for Automotive Diversity, Inclusion and Advancement, among others, to provide our Business Resources Groups (BRGs) with the tools to promote leadership and the resources designed to inform and engage.

Our partnerships with other organizations such as the CEO Action for Diversity and Inclusion and the Charta der Vielfalt in Europe create educational components to support our people along their education journeys.

Development

We offer development programs to empower employees in realizing their career aspirations.

DEI education development plans are required for Dana people at manager level or above along with effectively facilitating these conversations.

We also partner with consulting firms to create world-class development programs including a focus on mentorship and leadership.

Community

At Dana, our communities extend beyond mere physical spaces — they encompass where we live, work, and play. We recognize the importance of collaboration with local communities worldwide, especially when it comes to promoting more inclusive hiring practices.

Our business resource groups lie at the heart of our commitment. These voluntary, employee-led groups coalesce around shared identities, interests, and passions. They serve as vital bridges, connecting us to the diverse fabric of our workforce.

Dana's journey involves not just building products but also nurturing communities, fostering diversity, and embracing our collective responsibility. Together, we create a positive impact — one decision at a time.

Cross-functional Collaboration

We focus on people development, compensation, engagement, attraction, and retention to collaborate cross-functionally and ensure that inclusive and equitable structures and work practices are rooted in all Dana processes.

Diversity, equity, and inclusion is something that Dana people of all departments and all levels take part in leading.



DIVERSITY, EQUITY, AND INCLUSION

Embracing Diversity and Fostering Inclusion: Our Commitment at Dana

As a global organization, Dana thrives on the diverse perspectives and opinions across our workforce.

Our people hail from various cultures, backgrounds, and life experiences, creating a vibrant mosaic that fuels our success.

Together, they exemplify our unwavering commitment to fostering a collaborative workplace and remind us that our most valuable asset lies in the collective spirit of our people to find a better way.

Dana's ability to solve complex problems, think creatively, and drive continuous improvement stems from the multitude of viewpoints and voices within the organization.

To further champion this commitment, we proudly support and amplify our Business Resource Groups (BRGs).

These networks serve as vital conduits for valuing others, elevating diverse voices, and fostering engagement among both current and retired employees. By embracing diversity, equity, and inclusion, we cultivate an environment that inspires excellence and harnesses the collaborative power of our people.

Our eight BRGs — each led by passionate employees — serve as catalysts for growth, innovation, and inclusivity.

-  **African American Resource Group**
-  **Green Team**
-  **Alumni**
-  **LGBTQA**
-  **Connecting Cultures**
-  **Military and Veterans**
-  **DAWN**
Dana Women's Network
-  **New to Dana**

EMPLOYEE SPOTLIGHT

“At Dana, we are all about revolutionizing processes, increasing efficiency, and empowering teams to make data-driven decisions supporting our customers.”



Jamie Meyer
Senior HR Manager
United States

Days of Understanding

Dana's Days of Understanding were coordinated as part of our CEO Action for Diversity & Inclusion™ pledge which outlines a specific set of actions organizations are taking to cultivate a trusting environment where all ideas are welcomed, and employees feel comfortable and empowered to have discussions about diversity and inclusion.

At Dana, our locations around the world host DEI-related events which are facilitated by Dana people across all functions and levels. They include discussion guides, employee-signed pledges to help drive inclusive behaviors in everyday life, conversation starters around equity and equality, and more.

These training programs call for each of us to take a personal look at our own predispositions, conscious or non-conscious, and to engage in practical steps to recognize and overcome them.



DIVERSITY, EQUITY, AND INCLUSION

Dana and Purdue University Empower Students Through Robotics Challenge

Dana's African American Resource Group (AARG) joined forces with Purdue University, Indiana, United States, to host an exhilarating robotics challenge at our World Headquarters in Maumee, Ohio. The primary goal of this event was to introduce STEM programs to students and ignite their interest in engineering-related pursuits.

Enthusiastic participants, aged from 11-14, traveled from schools near Dana locations in Toledo, Ohio; Fort Wayne, Indiana; Pottstown, Pennsylvania; and Warren, Michigan — with expertise and oversight coming from Dana engineers and Virginia Booth Womack, Director of the Purdue Minority Engineering Program.

Each team received a robot kit. Their mission was to build, design, code, and program the robots to tackle specific challenges.

Over the course of three months, students collaborated with their school coaches and Dana engineers to hone their skills. Dana's AARG chapters organized local competitions at plant locations, preparing



Students participate in the Dana Robotics Challenge at the Dana World Headquarters in Maumee, Ohio, United States

the teams for the grand showdown at our World Headquarters.

The teams engaged in eight challenging tasks and those that scored the most points earned scholarships to attend Purdue University's MEP Summer

Engineering Workshop this summer — an exciting opportunity to further their engineering journey.

Dana's commitment to education, diversity, and hands-on learning shines through events like these.



International Women's Day #EmbraceEquity

International Women's Day 2023

Dana Women's Network (DAWN) Resource Group advances the promotion of professional networking and career development through mentoring, education, and philanthropy for women.

During International Women's Day (IWD), Dana's Senior Vice President and Chief Human Resources Officer celebrated with a video that was shared globally. And DAWN's global committee designed a toolkit for use at local celebrations across the world.

Other similar events led by Dana women and DAWN members spotlighted appreciation for women across our locations as well as advancing mentoring in STEM applications to inspire girls to become the next generation of engineers and researchers.

EMPLOYEE SPOTLIGHT

"Dana's African American Business Resource Group's mission is to have a positive and inclusive impact in our communities. From helping to fill local food banks, to our 'Angel Trees' in December — we take pride in helping others."

Lisa Long
Layout Inspector
United States



DIVERSITY, EQUITY, AND INCLUSION

Women Apprentices Power Brazil Operations



As part of a national effort to attract more women to manufacturing positions, Dana Brazil continues to take the lead in establishing the Women Apprentices in Operations Program, offering paid training to prepare women for work at Dana.

This 14-month program is offered to candidates who are 18-years or older, have completed high school, and are available for full-time participation.

Along with SENAI, a federal government industry support entity that provides training, and CIEE, which offers internship programs for companies throughout Brazil, Dana developed the training curriculum to advance essential skills in topics such as metrology, drawing reading and interpretation, quality, 5S, Dana products, and more.

After six months, they are ready to be hired as an apprentice or to fill in new vacancies. After two years, they can be hired as full-time employees.



Since its launch, the program has expanded to Dana's Jundiaí, Campinas, and Sorocaba locations.

So far, almost 40 women have completed the program and currently 60 are participating, many of whom will graduate this year.



EMPLOYEE SPOTLIGHT

“At Dana, we value others. As a member of the Veterans Committee, I take pride in assisting fellow veterans and contributing positively to our community.”

Melvin Sweeney
Quality Technician
United States

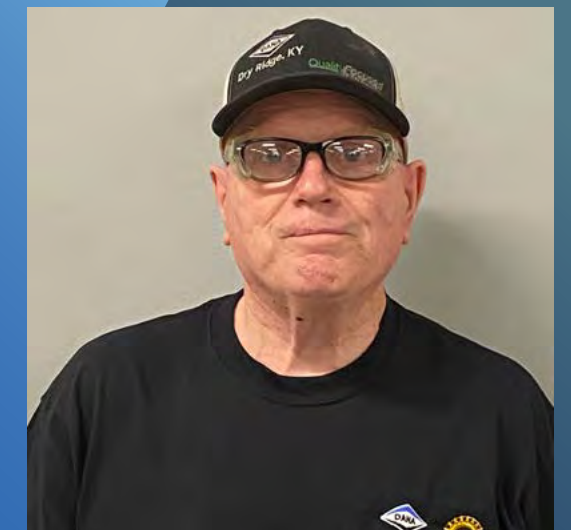

PEOPLE DEVELOPMENT

EMPLOYEE SPOTLIGHT

“I’m thrilled to be part of a team that strives for excellence. And always excited to work with talented new employees, helping to shape a more sustainable future for our planet.”

Morgan Knight
HR Manager
United States

The culture of developing people is in Dana’s DNA.

We have the conviction that people development is a key for Dana's long-term success. Therefore, we encourage open communication and foster our *People Finding A Better Way* spirit among teams so everyone has an opportunity to share, learn, and grow.

The foundations of a successful collaboration

It's important that we make every person feel welcome and valued from day one. Our employee value proposition offers career development opportunities, fair wages, and benefits.

Every employee’s journey starts with a personalized onboarding plan to lay the foundations of a successful collaboration through the “One Dana” approach.

This journey includes common learnings on Dana’s Culture, Business Conduct, Diversity, Equity and Inclusion, Safety First, Quality Focused, and the Dana Operating System, among others, as well as specific learnings linked to people's function and working environment (facility, colleagues, and resources).

Regular follow up, engagement, and onboarding surveys help us improve and adjust to set up new employees for success.

We also encourage our people to share their perspectives and ideas through skip-level discussions, and interactions with the leadership team.

Development programs

In addition to local training plans that all facilities support according to their specific needs, Dana offers a diverse set of development programs at regional, functional, and global levels.

Regionally, we partner with schools and universities to design specific programs to build technical and leadership skills. In Italy, for example, the Manager 4.0 program develops skills for middle operations managers and team leaders — leveraging Dana-specific tools and systems.

At a global level, we offer leadership and professional development training working with established international training organizations, such as GridWorks International, FranklinCovey programs, and the Hermann Brain Dominance Instrument.

To create strong leaders and ambassadors of the Dana culture, we offer a 3-day interactive workshop around leadership foundations for new managers. In 2023, more than 125 emerging leaders across the globe participated.

As a responsible organization, we invest in the next generation of employees by supporting strong apprenticeship and internship programs all over the world.

In several countries, these programs are designed so interns can experience various roles throughout the business, allowing

them to understand the company better and to discover new roles they may want to pursue.

Globally, we offer mentoring programs, allowing Dana people to learn from, and alongside, experienced leaders. We also organize regular skip-level discussions with leaders in our plants to foster open communication and two-way feedback.

Shared development plan

Dana is a dynamic organization providing many growth opportunities for employees.

We make sure our people are ready for their next steps by promoting regular, open, two-way discussions about career and development, by conducting regular talent reviews, and by ensuring all employees have a consistent shared development plan to keep learning and developing at all stages of their career.

On-demand learning

In addition to more structured learning, Dana people have access to a collection of on-demand learning materials via Skillport’s learning platform.

Using Skillport’s system, we focus on content of interest and areas of development, accessing both customized and generic learnings in over 15 languages across leadership, communication, engineering, finance, safety, quality, sales, and IT, among others.

PEOPLE DEVELOPMENT

Health and Wellbeing Spotlight

Health and wellbeing initiatives have long-lasting impacts, including enhancing creativity, resilience, job satisfaction, and work-life balance.

We are committed to providing all employees with quality and competitive benefit programs that focus on all aspects of employee wellbeing — including physical, mental, and financial. Our plans are benchmarked annually to ensure fit, competitiveness, and value.

Dana believes in:

- The importance of striving for personal and work-life integration.
- A supportive work environment that cultivates the drive to succeed.
- The importance of exploring new opportunities across the health and wellbeing spectrum.

Across the globe, Dana supports wellbeing initiatives that encourage good health and balance in our team members' lives.

We are committed to spreading awareness and support for a variety of topics that empower employees to be knowledgeable about good overall health.

Here are a few examples from around the world:

India

All locations celebrated World Yoga Day by planning activities that promoted the importance of good physical and mental health for employees.

United States

Dana World Headquarters continues their impactful mobile mammogram screening program to encourage preventative care for women's health.

United Kingdom

Dana teams launched month-long campaigns to support mental health programs and research for local men's health charities at both our Lindley and Chudleigh locations.

Expanded Virtual Capabilities

To encourage healthier lifestyles and preventative care awareness, Dana has expanded its benefit platforms to offer more virtual capabilities — allowing employees to have enhanced access to faster and more convenient care.

These added options include virtual primary care and virtual urgent care covered on

our employee health plans. Services are available seven days a week with more expanded hours than a traditional physician's office visit, and with the urgent care option, no appointment is required.

Our Employee Assistance Program also added enhancements that include virtual platforms and resources. TalkSpace gives employees a fully virtual counseling experience for more private and convenient mental health support that work around employees' schedules.

LearnToLive is a self-guided digital cognitive behavior therapy tool with personalized recommendations and support plans with access to clinical coaches by text, email, or phone.

MyHealthCheck360 brings wellness resources to employees with wellness newsletters, blogs, and health coaches ready to support health or fitness goals.

Multiple countries including Canada, India, and the United States, have offered awareness seminars hosted by external professionals including Gut Health Awareness and Prevention, Medicare 101 Resources, and financial education topics like estate planning.



EMPLOYEE SPOTLIGHT

“Sustainability and social responsibility are deeply integrated into our everyday operations. Whether it’s installing solar panels or launching community programs supporting local schools and female entrepreneurs — we strive to give back to the environment and society.”



Vikas Kurkute
Plant Manager
India

A woman with dark hair tied back, wearing safety glasses and a dark blue zip-up jacket with white stripes on the sleeves, is focused on working on a grey metal box. She is wearing blue work gloves with 'ULINE' written on them. The box has an orange connector and some wires. The background is a large industrial warehouse with high ceilings, metal shelving units, and various equipment. The lighting is bright and even.

Innovation.
Here for it.

Supporting Lamborghini with 8-Speed Hybrid Dual Clutch Transmission

We were chosen by Automobili Lamborghini S.p.A. to develop and build an 8-speed, dual-clutch hybrid transmission for its powerful V12 engines, establishing a new input torque and speed capacity benchmark for the super sports cars segment. Depending on its configuration, the mid-engine, transverse transmission can be leveraged for battery recharge, torque boost, or EV drive, offering flexibility without sacrificing performance.

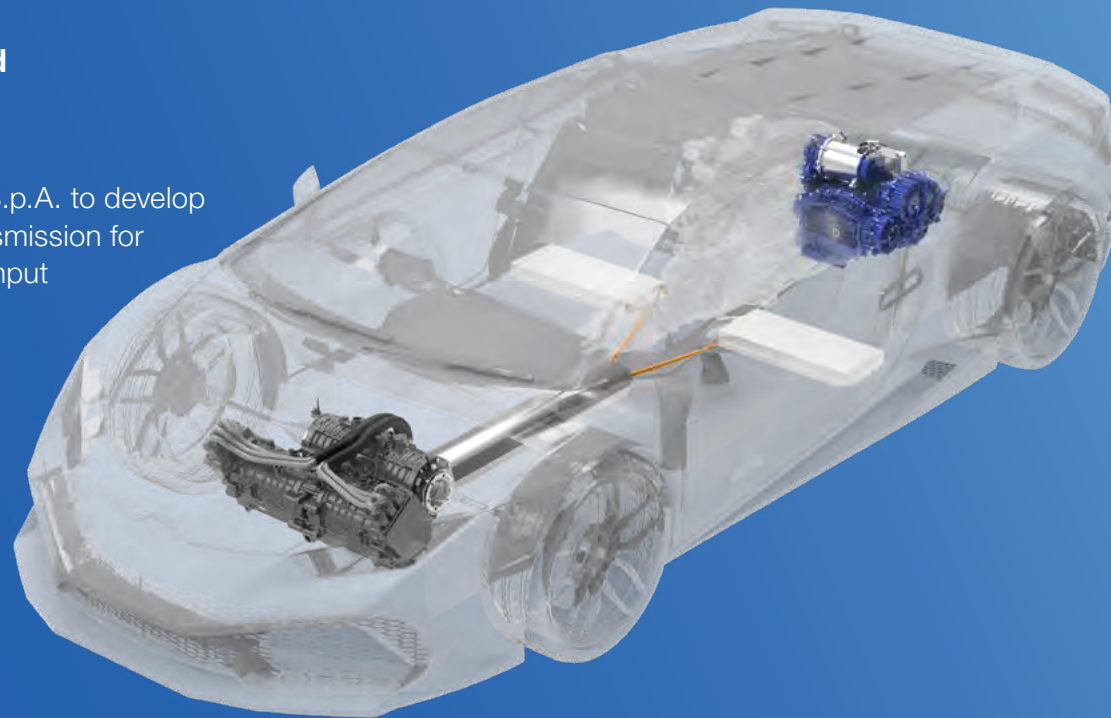

EMPLOYEE SPOTLIGHT

“Our design process drives innovation — propelling customers on their electrification journey.”



Heidi Koedam

Director, Technology and Core Initiatives
United States

Automotive News PACE Award Success for Dana and Oshkosh Corporation Innovation

Together with Oshkosh Corporation, we developed the Electro-Mechanical Infinitely Variable Transmission for commercial vehicles. This technology was named a winner of the 2024 *Automotive News* PACE Award and is being initially deployed in applications such as Pierce Manufacturing's fire trucks and Oshkosh Airport Product's aircraft rescue and firefighting vehicles. The product technology and software are also synergistic with Dana's integrated powertrains that support the off-highway and light-vehicle markets. Dana has won nine *Automotive News* PACE Awards and been named a finalist on 25 occasions.

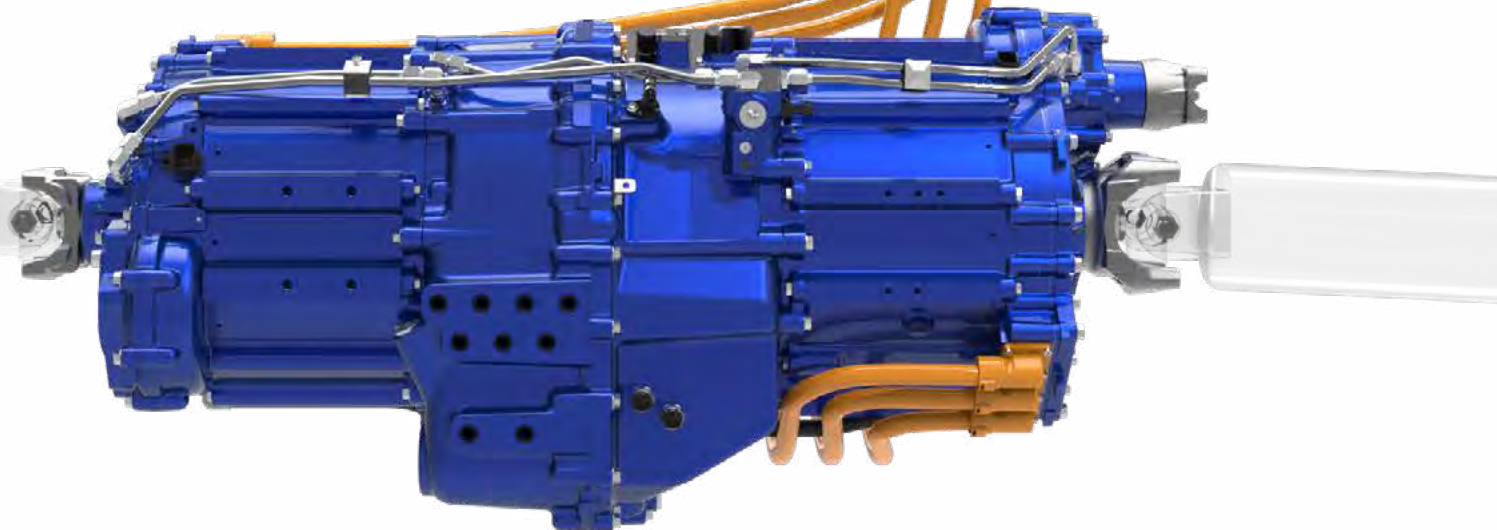

Wacker Neuson e-Mobility Program

Dana was selected by the Wacker Neuson Group to supply the e-Propulsion system for its compact, construction vehicle range in Europe. The multi-year program features a comprehensive electrodynamic system from Dana, encompassing the Spicer Electrified™ eSG101 e-Transmission, Dana TM4™ SRI 200 motors, AC-X1 inverters, an APC 300 series controller, and accompanying software for managing vehicle traction and operations.

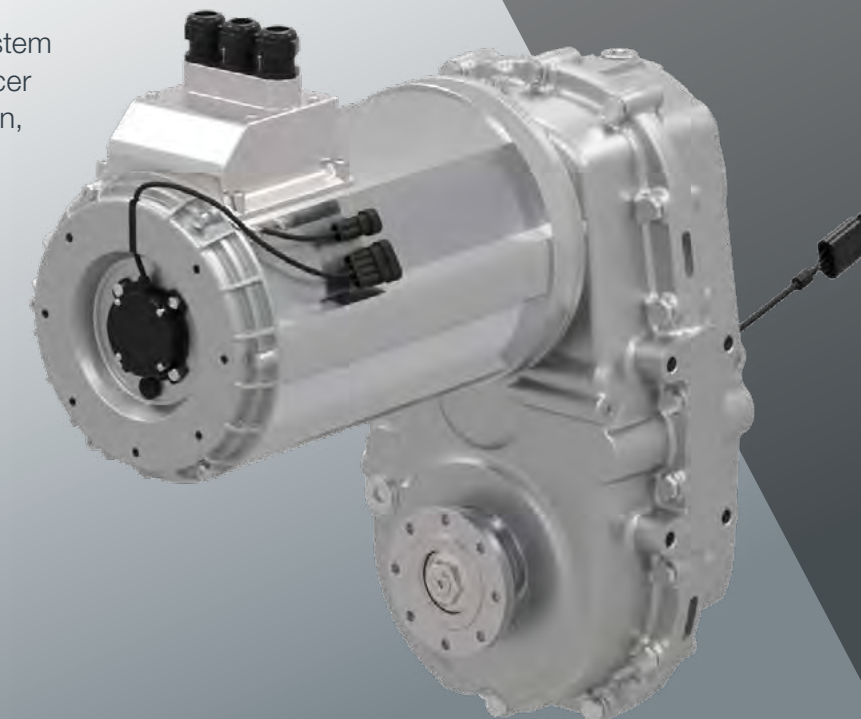



Metallic Bipolar Plates for Hydrogen Electrolyzers

We introduced metallic bipolar plates engineered to optimize performance and hasten the commercialization of proton exchange membrane (PEM) electrolyzers for hydrogen fuel production. Leveraging more than two decades of expertise in similar components for fuel cell stacks in mobile applications, Dana's integrated bipolar plates feature steel or titanium construction with various coatings, enhancing stack efficiency and sealing integrity. This initiative affirms Dana's commitment to driving the energy transition with innovative solutions.

Improving Turf Management, Sustainably, with Electric Zero-Turn Mowers

We unveiled an electric zero-turn mower solution featuring compact Spicer Torque-Hub™ drives and Dana TM4™ motors — enhancing zero-emissions operation through powerful torque, extended work times, reduced maintenance, and lower noise.



Powering the Construction Industry with the Launch of the Spicer Electrified™ eSP502 e-Transmission

Dana unveiled new initiatives reinforcing its commitment to the North American construction and off-highway markets, including the introduction of electrified drivetrain offerings and expansion of production capabilities. The Spicer Electrified™ eSP502 e-Transmission features a dual-motor, two-speed design built on a flexible platform for optimized performance in compact off-highway vehicles. Additionally, we introduced a modular Spicer® drivetrain solution for telehandlers and expanded production of Spicer Torque-Hub™ track drives.



EMPLOYEE SPOTLIGHT

"I take great pride in leading programs at Dana. Whether powering the e-Mobility market or fostering a more sustainable environment for future generations. It's a place where we get important work done."

Haley Yonker
Sr. Global Program
Manager, Electrification
United States



GLOBAL TECHNOLOGY CENTERS

Dana's global network of technology centers across 10 countries allow us to innovate near and with our customers.

Dedicated to the pursuit of new ideas, products, and services — they are home to thousands of the world's leading engineers, technicians, and scientists developing breakthrough advances in next generation clean-energy technologies and sustainable products.

We push new boundaries, and deliver on-the-ground, local solutions for customers as they continue to accelerate their electric vehicle portfolio development.

We also recognize the importance of strong relationships with our academic partners. Our global network of universities throughout the Americas, Europe, and Asia provides a path for research and development, professional education, and career opportunities transforming the future of mobility.

Belgium

Brazil

Canada

China

Germany

India

Italy

Sweden

United Kingdom

United States of America



QUALITY SIGNATURE

Commitment to Excellence

At Dana, we power innovation to move our world. The vehicles and machines we develop support people’s lives. So, we take ownership of our actions.

Pursuing excellence. Operating to the highest standards. Having a zero-defect mindset. Being Quality Focused — All Day, Every Day.



This approach is built around three key voices: Voice of Customer, Voice of Process, and Voice of Systems. They refer to the quality standards and tools that create value and elevate Dana as the supplier of choice in our industry.

Voice of Customer

In 2023, Dana received more than 55 individual awards and recognitions from customers and the industry, including multiple supplier of the year awards.

Our customers have choices, and they continue to entrust Dana with many of their most technologically advanced vehicles. They expect high levels of customer satisfaction and product safety.

We therefore work to ensure that our processes and systems conform not only

to our customer-specific requirements, but also regulatory requirements in addition to our internal design standards and guidelines. Dana processes are heavily focused on driving excellence through the earliest stages of product design, development, and industrialization.

We prioritize preventative measures through a series of best practices, lessons learned, product and quality reviews, and data analytics. These occur at every stage with product development, manufacturing, supply chain, and commercialization to ensure that our products are high quality, safe, and reliable.

Dana’s end-to-end total quality approach is supported by a real-time quality dashboard KPI management system, structured problem-solving process resolving issues

and concerns quickly, as well as an interactive QMS model for policies and procedures.

Changing Our World Through e-Propulsion

74% of Dana’s new business backlog now comes from innovating next-generation clean-energy technologies. As we grow our electrification portfolio we are continually expanding the use of quality systems earlier in the process to address control, detection, and compliance.

We have adapted to customer needs in this rapidly growing segment and can deliver all elements — from a component level to a complete, fully integrated electrified system — across any mobility market anywhere in the world.



EMPLOYEE SPOTLIGHT

“Bridging the gap, one operation at the time. When cutting-edge inspection techniques intersect with technology — we ensure traceability, stringent production controls, and unwavering product quality.”



Latoya Blackwell
Sr. IT Operations Analyst
United States

QUALITY SIGNATURE



Our team of quality professionals are dedicated to software and hardware quality assurance powering the highest levels of product integrity and have achieved Automotive, Software Process Improvement and Capability e-Determination industry-standard guidelines credentials.

Software assurance and functional safety assessments, audits, and process checks are regularly conducted and reviewed. This provides accountability and transparency in the design review and product realization process. Lastly, governance and leadership oversight are provided through our Corporate Quality and Product Safety Council serving the needs of our stakeholders and business requirements.

Voice of Process

Dana empowers operational performance through innovative and transformative manufacturing processes. We continued the expansion of our operational excellence strategy through digital transformation including over 100 enhancements in digital shopfloor management, quality interlocks, and process capability reporting. To this end, Dana's external auditors recognized our Quality Dashboard as "best in class."

Our Read Across electronic app continued to communicate lessons learned and best practices within our global footprint.

A good example of Dana innovation are our collaborative robots performing tasks such as weld inspection which offers a technical robust application with tighter manufacturing process controls and eliminates manual visual inspections while building in quality at source.

Other applications include process simulations utilizing design for assembly and manufacturing methods integrated



with Dana's standard equipment, controls, and traceability requirements. Dana has also developed machine learning tools and applications, addressing process variation and feature verification.

Voice of System

During the year, we saw how the power of our Quality Focused strategy, systems, standards, and tools provided the blueprint for consistency — effectively increasing our performance and delivery.

Being problem solvers — *People Finding A Better Way* — gives us invaluable opportunities to gain experience in an open, no blame environment where we see challenges as treasures. It builds relationships and trust.

In essence, our foundation is a quality culture that drives continuous improvement.

Dana's electronic KPI management system, dashboard, and planning tools are accessible to all Dana team members advancing accountability and transparency.

This allows for speed and agility in supporting data-driven decision making across the globe.

While the quality system is controlled by the corporate global quality team, local management teams support the execution of these guidelines, systems, and processes. This approach was recognized by the International Automotive Task Force global audit performance which, in 2023, spotlighted Dana's continuous improvement.

As we partner with those who think without limits across 88 major manufacturing locations in 31 countries, ensuring system robustness and compliance is key to winning together.

QUALITY SIGNATURE

Customer Awards 2023



Hinduja Group Innovation Gold Award
India

Zero PPM - Platinum Award
Noida, India



Supplier Excellence Recognition Process - Excellence Level
Pune, India



Corporate Responsibility Direct and Indirect Sourcing Award
North America

Runner-Up Corporate Responsibility Direct and Indirect Sourcing Award
Global

DAIMLER TRUCK

Daimler India 2023 Delivery Award
Pune, India



Reliability Award
Pune, India



Supplier Partner Award
Global



Ford Quality Award
Yancheng, China

Q1 Gold Award
Querétaro, Mexico



2022 Supplier of the Year
Global

1st Place - 2023 Supplier Innovation Bootcamp
Columbia, United States

GM Customer Care and Aftersales On-Time Shipping Award
Chatham, Canada (Gold)
Oakville, Canada (Platinum)
Power Technologies Sealing Division

Supplier Excellence Award (BIQS)
Bucaramanga, Brazil



2023 Supplier of the Year
Global



Best Supplier Award
Dana TM4 India



NPIP Delivery Performance Award
Kolhapur, India



JLRQ Quality Award
Győr, Hungary



Best in Quality & Delivery Performance
Kolhapur, India

Partner Level Award
Kolhapur, India



Best Quality Award 2022
Pune, India



10PPM Quality Standard Award
Danville, United States
Neu-Ulm, Germany
Queretaro, Mexico
Jundiai, Brazil
India



Award for Quality Excellence
Pune, India



Partner-Level Supplier Award
Kolhapur, India



2022 Excellence Award for Supplier Diversity
Global

Logistics Award
Grand Bourg, Brazil



Best Quality Supplier 2023
Wuxi, China



Outstanding Quality and Delivery Performance
Noida, India



Supply Partner Award
Sorocaba, Brazil



Strategic Supplier Award
Arco, Italy
Győr, Hungary
Brugge, Belgium
Weifang, China

Acting **NOW**
to protect our
shared planet.



SUSTAINABILITY IN ACTION

Sustainability Award Winners 2023

Across our operations, we progress hundreds of global efficiency projects annually. Dana's Sustainability Award Winners exemplify the collaborative efforts from teams around the world driving positive action for our shared planet. The 2023 Sustainability Awards were presented by Doug Liedberg, Dana's Chief Compliance and Sustainability Officer.

Dana Querétaro, Mexico

During the year, the facility undertook numerous high-impact initiatives encompassing renewable energy, lighting, and natural gas optimization.

Most notably, this included working to secure a major renewable energy contract supplying 100% clean energy and eliminating over 35,000 metric tons of GHG emissions annually (equivalent to emissions avoided by over nine wind turbines running for a year).

Other enhancements at Dana Querétaro included LED lighting in key production areas and upgrades to production furnaces lowering natural gas consumption.

Dana Yancheng, China

Our Dana Yancheng team has been recognized for its ongoing commitment to innovation. Advancements across renewable energy included installing solar roof panels which met 33% of the facility's energy requirements in 2023.

This was supplemented by locking in a long-term renewable energy power purchase agreement. Use of renewable energy at Dana Yancheng eliminated over 1,250 metric tons of GHG emissions (equivalent to carbon sequestered by 20,000 tree seedlings grown for 10 years).

Other standout projects included installation of natural skylights and a leading-edge air emissions handling system.

Global Purchasing Team

Dana's Global Purchasing team is being recognized for exceptional environmental stewardship driving sustainability across the enterprise. This team collects, analyzes, and manages Dana's global spend — prioritizing key metrics such as climate impact, natural resource use, human rights, and diversity.

Highlights include their work incorporating ESG data into our global sourcing strategies. ESG data comprises a significant portion our supplier scorecard which we use to assess and select our suppliers.

The team also facilitated multiple, global clean energy sourcing agreements, and launched the company's participation in the One Tree Planted Initiative.



Dana's Purchasing Decision Matrix

Every Decision Counts

Total Cost

- Cost
- Working Capital
- Tariffs and Duties
- Logistics

Quality

- Delivery
- Parts per Million Defective

ESG

- Environmental
- Human Rights
- Safety
- Security
- Governance
- Compliance

Collaboration

- Transparency
- Agility
- Technology

Diversity, Equity, and Inclusion

- Women Owned
- Minority Owned
- Veteran Owned
- LGBTQ Owned
- Other

Risk

- Performance
- Financial
- Geopolitical
- Reputation





One Community.

ONE COMMUNITY

We take great pride in collaborating with organizations that are actively making a positive impact in our local communities.

It is crucial for us to establish our identity and values within the community, so that we can build strong relationships and effectively contribute towards our shared goals.

We celebrate those teams and individuals who come together to build and nurture causes close to their heart and make a positive impact in the places where we do business and call home.

These include supporting young students, donating food to local food banks, charity fundraising, cleaning roads and trails in local parks, and partnering with impactful, socially minded organizations.

Here are just a handful of examples of how our people around the world made a difference during the year.

BRUGGE, BELGIUM
Corporate Cycling Challenge

Employees from Dana Brugge competed in the Corporate Cycling Challenge in Ostend to raise money for local charities.

BOUCHERVILLE, CANADA
Dana Boucherville's Make-A-Wish Race

Members of the Dana TM4™ team in Boucherville participated in a 48-hour Make-A-Wish bicycle race to help raise money for those in need.

WUXI, CHINA
Hiking Challenge

Over 300 members of Dana's Wuxi team joined a hike around Lake Tai raising awareness for green transportation.

GYŐR, HUNGARY
Teaching the Next Generation

Our Dana Hungary team hosted a group of university students from Széchenyi István University, teaching our latest developments in advanced Industry 4.0 technologies, driveline product assembly, and lean methodology processes.



BRAZIL
Food Drives

Our Brazil team donated over 50,000 meal kits in 2023, supporting those in need.

ITALY
Celebrating Cultural Diversity

Dana teams in Italy celebrated World Day for Cultural Diversity for Dialogue and Development, spotlighting the uniqueness of every culture within Dana.

DRY RIDGE, UNITED STATES
Raising Money for St. Jude Children's Hospital

Our Dry Ridge colleagues participated in the 5th Annual Tin Cup Golf Open, helping to raise more than \$20,000 for St. Jude Children's Hospital.

BRAZIL
Clothing Drives

Our teams in Brazil were able to collect and donate more than 14,000 clothing items in five cities for those in need during the winter.

CHANGSHU, CHINA
Earth Day

China teams celebrated Earth Day on April 22 including roadside clean-ups and environmental awareness with local primary school students.

BRAZIL
Blood Donations

Over 250 members of Dana's Brazil team donated blood throughout the year.

EMPLOYEE SPOTLIGHT



Marcell Kiss
EHS Coordinator
Hungary

Monika Nemeth
Project Administrator
Hungary

“Our ‘Do One Thing’ environmental awareness program spotlights individual responsibility. It’s a great example of how small actions collectively contribute to a greener future in harmony with our core values.”

ONE COMMUNITY**BRAZIL****Food Donations for Flood Victims**

As climate events impact our communities, Dana teams in Brazil joined forces to donate one ton of non-perishable food to those experiencing hardship.

INDIA**Empowering Women in India**

Our team in India facilitated milk collection centers in partnership with the Karnataka Milk Federation, with the involvement of over 150 farmers.

BOUCHERVILLE, CANADA**Sponsoring Students to Pursue Renewable Energy**

The Dana TM4™ team in Boucherville sponsored a student group to design a solar vehicle that can travel thousands of kilometers.

INDIA**Further Education Initiatives**

The Dana Anand India Pvt. Ltd. (DAIPL) Medhavi Scholarship Program supports young women pursuing engineering diplomas from renowned Indian polytechnics and helps to secure placement post-graduation.

CROSSVILLE, UNITED STATES**Local Food Pantries**

On behalf of Dana's Foundation Southern Region, the team at Crossville donated money to Cumberland County United Fund to support local food pantries.

PUNE, INDIA**Advancing Education**

Our India team continued their work constructing primary school buildings and enhancing classrooms promoting primary education and empowering local communities.

JAGMIN VASTI, INDIA**Solar Lift Irrigation System**

Dana India's support for a solar lift irrigation initiative benefited 200 farmers with access to water for agriculture, promoted sustainable and eco-friendly practices and enhanced crop yields.

WARREN, UNITED STATES**Adopt-A-County Road Program**

Our African American Resource Group at Dana Warren participated in the Adopt-A-County Road program, helping to clean a one-mile stretch of road near the plant.

DANVILLE, UNITED STATES**Support for Local Organizations**

Dana's Danville team presented several local organizations (including military, mental health, elderly support and scholarship programs) with money on behalf of the Dana Foundation's Southern Region.

NOVI, UNITED STATES**Connecting Cultures BRG's Potluck Lunch**

Dana's Business Resource Group "Connecting Cultures" hosted an international-themed lunch at the Novi Technical Center where international dishes were shared to promote the various cultures that make up Dana.

UNITED STATES**Dana Named Adoption Advocate**

For the second consecutive year, Dana has been named as an adoption advocate by the Dave Thomas Foundation for Adoption.

**EMPLOYEE SPOTLIGHT**

“At Dana, we drive sustainability not only through innovative electrified product design — but by partnering with startups and environmentally conscious suppliers. Together, we foster a greener future.”

Sarah Armbruster
Advanced Sustainability Engineer
United States



Corporate
culture **matters.**



LEADERSHIP

Board of Directors

Ernesto M. Hernández^{1, 3}

Retired President and Managing Director of General Motors de México

Director since 2022

Gary Hu^{2, 3}

Portfolio Manager for Icahn Capital L.P.

Director since 2022

James K. Kamsickas

Chairman and Chief Executive Officer of Dana Incorporated

Director since 2015

Bridget E. Karlin^{1*, 4}

Senior Vice President of Information Technology at Kaiser Permanente

Director since 2019

Michael J. Mack, Jr.^{1, 2*, 5}

Retired Group President of John Deere Financial Services, Global Human Resources, and Public Affairs at Deere & Co.

Director since 2018

R. Bruce McDonald^{2, 3*, 5}

Retired Chairman and Chief Executive Officer of Adient plc

Director since 2014

Steven D. Miller^{1, 4}

Portfolio Manager at Icahn Capital L.P.

Director since 2023

Diarmuid B. O'Connell^{2, 4*}

Former Vice President of Tesla, Inc.

Director since 2018

Keith E. Wandell^{3, 4, †}

Retired President and Chief Executive Officer of Harley-Davidson, Inc.

Director since 2008

¹ Member: Compensation Committee

² Member: Audit Committee

³ Member: Nominating and Corporate Governance Committee

⁴ Member: Technology and Sustainability Committee

⁵ Financial Expert

* Committee Chair

† Lead Independent Director

 For full biographies, please refer to [Dana.com/investors](https://dana.com/investors)

Corporate Officers

James K. Kamsickas

Chairman and Chief Executive Officer

Aziz S. Aghili

Executive Vice President and President, Commercial Vehicle Drive and Motion Systems

Chris J. Clark

Senior Vice President, Global Operations

Jeroen B. Decler

Senior Vice President and President, Off-Highway Drive and Motion Systems

Christophe J. Dominiak

Senior Vice President and Chief Technology Officer

Byron S. Foster

Senior Vice President and President, Light Vehicle Drive Systems

Timothy R. Kraus

Senior Vice President and Chief Financial Officer

Douglas H. Liedberg

Senior Vice President, General Counsel, Secretary, and Chief Compliance & Sustainability Officer

Maureen S. Pittenger

Senior Vice President and Chief Human Resources Officer

M. Craig Price

Senior Vice President, Purchasing and Supplier Development

Andrea C. Siudara

Senior Vice President and Chief Information Officer

Antonio Valencia

Senior Vice President and President, Power Technologies and Global Electrification

ETHICS AND INTEGRITY

World's Most Ethical Companies

Dana was again recognized as one of the 2024 World's Most Ethical Companies® by Ethisphere, a global leader in defining and advancing the standards of ethical business practices.



In 2024, a total of 136 companies spanning 20 countries and 44 industries were recognized. Dana is one of only eight honorees across the mobility industry.

This prestigious recognition celebrates Dana's unwavering commitment to business integrity and recognizes a people-first culture where we foster exceptional stakeholder relationships through clear values and ethical standards.

We are committed to operating the business the right way, with best-in-class ethics, compliance, and governance practices, as well as environmental and social impact programs.

Tone From the Top

Across our global operating environment, one thing remains constant at Dana — our commitment to integrity and ethical business practices.

We have earned our customers' trust by delivering outstanding service and demonstrating an unwavering commitment to ethics.

For 120 years, we have been working together to deliver solutions that support our customers around the world.

As we ship to more than 13,000 customers in 141 countries, every employee is obligated to act with the highest degree of integrity and in full compliance with the law.

Business Conduct and Ethics

We believe that good corporate governance reinforces the message that Dana conducts business in a legal, ethical, and responsible manner, respecting human rights in all that we do.

At Dana, business conduct and ethics are addressed through various programs to maintain a culture where each of us feel comfortable asking questions, speaking up, and working towards solutions.

These processes include reporting, investigation and remediation, certification and audits, and continuous training and education.

Upon joining Dana, salaried employees undertake a series of mandatory business conduct modules which include promoting honesty, integrity, mutual respect, and compliance with all of our policies.

We believe in ongoing training and education to ensure that employees take an active role in understanding the policies affecting their job and wellbeing.

In 2023, mandatory training programs included anti-harassment, effective trade compliance, protection against ransomware, and surviving an active threat.

Additional modules on ethics and compliance are also regularly integrated into other training initiatives from in-person team meetings and town halls to video messages, newsletters, and podcasts — all helping to drive a culture of ethics across the organization.

Ethics and Compliance

Dana's Standards of Business Conduct are the cornerstone of our business ethics and compliance outreach.

They provide guidance to Dana people regarding specific legal and business conduct risk areas and work in parallel with other core corporate, operational, and functional policies that govern the conduct of all employees.

Our employee on-boarding process involves a written acknowledgment of the receipt and review of the Standards of Business Conduct and other policies.

In addition, all salaried employees are expected to complete an annual

questionnaire designed to identify any business conduct concerns.

Dana has a specific policy for handling internal investigations of possible business conduct and ethics violations and other matters involving fraud, theft, ethics, or financial reporting concerns.

This policy establishes an affirmative obligation for employees to report ethics and business conduct matters that come to their attention. It also identifies the process for handling investigations, oversight, reporting, and related issues.

See our Standards of Business Conduct

Ethics and Compliance Helpline

We maintain a global Ethics and Compliance Helpline. This valuable communication tool is available in multiple languages (by both telephone and e-mail) and can be used by our people to anonymously raise concerns related to any alleged ethics or business conduct matters outside of their normal reporting channels.

In 2023, Dana's Ethics and Compliance system logged 201 cases, of which nine percent were found to be substantiated after investigation.

Dana's responses were based on the facts involved in each matter and included coaching and / or other formal disciplinary actions.

We continue to drive our business in an ethical manner to help ensure the long-term success for our people, our customers, our communities, and our shareholders.

ETHICS AND INTEGRITY

Standards of Business Conduct

Our Standards of Business Conduct set forth the behavioral expectations we have of our people as we conduct our operations around the world.

They cover a range of subjects including respect in the workplace, environmental protection, health and safety, use of corporate assets, conflicts of interest, and protection of confidential information among many other topics.

The Standards apply to all employees of Dana. We also expect that anyone acting on our behalf — including contractors, consultants, and other third parties — will observe the same high standards of business conduct and fulfill their contractual obligations.

Dana employees have a responsibility to:

- **Conduct business legally and ethically.** To know and comply with our Standards of Business Conduct, as well as the laws, regulations, and policies that apply to their location and role at Dana.
- **Ask for guidance.** To reach out any time they are unsure of the proper course of action. This includes their supervisors, the Dana Law Department, Human Resources, or the Internal Audit Department.
- **Share concerns if misconduct is suspected.** To realize that doing nothing or looking the other way is never acceptable and can have serious consequences for them and our company.
- **Never compromise.** To always conduct business the right way — and with the right values — consistent with our Standards.

Supplier Code of Business Conduct

Dana operates at scale. We employ 42,000 people across 88 major facilities in 31 countries. We ship to 13,000 customers in 141 countries.

We recognize that Dana is an essential component in a global supply chain serving customers worldwide.

We know that our performance, and the performance of our supply chain, is important to our customers and positively impacts their sustainability objectives.

Therefore, it is essential that our suppliers also understand and appreciate the standards of business conduct that are expected of any company that conducts business with Dana.

For that reason, we maintain a robust, interactive Supplier Code of Business Conduct that clearly communicates our business conduct expectations to Dana's suppliers. The Supplier Code of Conduct is also a contractual obligation in most Dana supply agreements.

Among a comprehensive list of standards, our code addresses:

- Respect for People: Inclusion and Diversity
- Safe and Positive Workplaces
- Environmental Protection and Sustainability
- Conflict Minerals and Other Product Origin Obligations
- Product Safety
- Gifts, Favors, and Entertainment
- Conflicts of Interest
- Negotiating Fairly and Honestly

To ensure we reinforce these values clearly and consistently around the world, our Standards of Business Conduct and our Supplier Code of Business Conduct have been translated into 20 languages and are publicly available on our website.

[See our Standards of Business Conduct](#)

[See our Supplier Code of Business Conduct](#)

Cybersecurity Spotlight

Dana's Global Cybersecurity team ensures compliance and safeguards our entities and assets against threats to our systems, operations, and reputation.

Cybersecurity is the practice of protecting the confidentiality, integrity, and availability of assets (data, systems, networks, and programs) from digital attacks. This represents a priority focus on operational excellence and ensuring that systems are maintained and upgraded to protect Dana and our customers.

Throughout 2023, Dana Cybersecurity teams further advanced governance, risk and compliance functions, data protection, and expanded security operations functionality and monitoring.

In addition, identity management improvements included the implementation of a Privileged Access Management system while continuing to centrally manage Dana's domain.

We continue to focus on the cybersecurity culture and awareness training of our employees. Mandatory training is administered and monitored, maintaining over a 99% completion rate globally.

Ongoing simulated phishing campaigns targeting relevant topics and additional training videos on other phishing attacks like smishing (texting) and vishing (voice) are conducted to further train our people.

Dana also conducts tabletop exercises and business continuity reviews for key insights on cybersecurity incident response program.

Our Information Security Policy design aligns to ISO 27001 and follows the National Institute of Standards and Technology (NIST) framework controls and we conduct self-assessments semi-annually and third-party audits against the NIST framework.

Four key tenets — Operational Excellence, Technology, Business Continuity and Recovery, and IT Risk Management and Compliance — underpin Dana's robust cyber security strategy as it engages across the entire company to protect our people and increasingly digitized business operations.



EMPLOYEE SPOTLIGHT



Yun (Ellen) Lu
 Senior Manager,
 Light Vehicle Cybersecurity
 United States

“We are fully dedicated to safeguarding the cybersecurity of our systems — driving an ever safer and more secure mobility ecosystem for everyone.”

An aerial photograph of a solar farm. In the foreground, several rows of blue solar panels are visible, separated by gravel paths. A large, light-colored stone wall runs across the middle ground. In the background, a large industrial building with a blue stripe and the text "Tobtec Drive line" is visible. To the left, a tall brick chimney has the word "OVERLAND" written vertically on it. The sky is blue with scattered white clouds.

Appendix

METHODOLOGY

Using the Global Reporting Initiative (GRI), Sustainable Accounting Standards Board (SASB), Task Force on Climate-related Financial Disclosures (TCFD), and United Nations Sustainable Development Goals (SDGs) guidance, we identified possible topics, prioritized the topics, validated the results, and adopted the list of material topics for our Sustainability and Social Responsibility reporting strategy.

Step 1: Identification

- Identified internal and external sources of information to score for prioritization.
- Benchmarked our peers and customers on sustainability and social responsibility practices.
- Created a high-level value chain map to identify sustainability and social responsibility impacts, risks, opportunities, and boundaries.

Step 2: Prioritization

- Gathered perceptions of stakeholder priorities based on associated facts and evidence, including 18 internal stakeholder interviews, 21 external stakeholder interviews, and internal/external score sourcing.
- Scored and synthesized feedback to present final materiality results reflecting feedback from stakeholders, peer benchmarking, and relevant industry standards and studies.

Step 3: Validation

- Validated the materiality matrix through discussion with key leaders about prioritized material topics, associated boundaries, and opportunities.

Step 4: Adoption

- Determined and/or refined the management approach regarding the most significant topics.
- Set or refined goals, performance indicators, strategies, partnerships, and internal controls.
- Established the materiality assessment as the basis for ongoing ESG strategy, goal setting, and reporting.

Material Topics

Issues

- Innovation and Product Lifecycle
- Talent Management
- Occupational Health, Safety and Wellness
- Ethical Business Practices
- Diversity and Equal Opportunity
- Business Continuity / Risk Mitigation / Supply Chain
- Product Quality and Safety
- Energy Consumption and Emissions
- Solid Waste
- Water and Effluents

Stakeholder Engagement

Continuous engagement and regular dialogue with our seven defined stakeholder groups, through formal and informal processes, provides us the opportunity to innovate and proactively manage the emerging environmental, social, and governance (ESG) needs and risks.

In addition to ongoing internal stakeholder engagement, we regularly engage with our external stakeholders on trending and emerging issues that matter to them through inquiries and requests for information related to our ESG practices as well as through periodic surveys answered at the request of various customers and investors.

In addition to engaging with internal and external stakeholders to evolve our ESG execution, we understand that increased transparency helps us effectively improve our business over the long term.

A list of external charters and associations Dana is actively engaged with include:

- American Bar Association Diversity & Inclusion Initiative
- American Society of Safety Professionals (ASSP)
- Association of Equipment Manufacturers (AEM)
- Automotive Industry Action Group (AIAG)
- Board of Certified Safety Professionals (CSP)
- Canadian Center for Women in Science, Engineering, Trades and Technology
- CEO Action for Diversity & Inclusion
- Center for Automotive Diversity, Inclusion & Advancement (CADIA)

- Chartered Institute of Procurement & Supply (CIPS)
- CDP (fka Carbon Disclosure Project)
- Ethisphere Institute
- Global Reporting Initiative (GRI)
- Great Lakes Women's Business Council (Great Lakes WBC)
- Human Rights Campaign Corporate Equality Index
- Institute of Hazardous Materials Management (IHMM)
- Institutional Shareholder Services (ISS)
- International Organization for Standardization (ISO)
- Leadership in Energy & Environmental Design (LEED)
- Manufacturers Alliance for Productivity and Innovation (MAPI)
- National Institute of Standards and Technology (NIST)
- National Society of Black Engineers (NSBE)
- Regional Growth Partnership, Northwest Ohio
- S&P Global Corporate Sustainability Assessment (CSA)
- Science Based Target Initiative (SBTi)
- Sustainable Accounting Standards Board (SASB)
- United Nations Global Impact
- United Nations Sustainable Development Goals (SDGs)
- Task Force on Climate-related Financial Disclosures (TCFD)

United Nations Sustainable Development Goals Index

The Global Reporting Initiative is the independent international organization that helps businesses and other organizations take responsibility for their impacts, by providing global common language to communicate those impacts. They provide the world's most widely used standards for sustainability reporting – the GRI Standards.

The 2030 Agenda for Sustainable Development, adopted by all United Nations Member States in 2015, provides a shared blueprint for peace and prosperity for people and the planet, now and into the future. At its heart are the 17 Sustainable Development Goals (SDGs), which are an urgent call for action by all countries - developed and developing - in a global partnership. They recognize that ending poverty and other deprivations must go hand-in-hand with strategies that improve health and education, reduce inequality, and spur economic growth – all while tackling climate change and working to preserve our oceans and forests.

Within the report index, Dana is providing the linkages between the reporting framework content – Global Reporting Initiative (GRI), Sustainable Accounting Standards Board (SASB), and Task Force on Climate-related Financial Disclosures (TCFD) – and their relationship with the 17 United Nations SDGs listed here.



GLOBAL REPORTING INITIATIVE (GRI) INDEX

The Global Reporting Initiative is the independent international organization that helps businesses and other organizations take responsibility for their impacts, by providing global common language to communicate those impacts. They provide the world’s most widely used standards for sustainability reporting – the GRI Standards.

Disclosure Number	Disclosure Title	2023 Response	SDGs
GRI 102: General Disclosures			
Organizational Profile			
102-1	Name of the organization	Dana Incorporated	N/A
102-2	Activities, brands, products, and services	Dana 2023 Sustainability & Social Responsibility Report: Dana: Overview Dana 2023 Annual Report pages 1 - 17	N/A
102-3	Location and headquarters	Dana’s corporate offices are located at: Dana Incorporated 3939 Technology Drive Maumee, OH 43537, USA	N/A
102-4	Location of operations	Locations	N/A
102-5	Ownership and legal form	Dana Incorporated (NYSE: DAN) is a publicly held corporation incorporated in the state of Delaware. Our shares trade on the New York Stock Exchange.	N/A
102-6	Markets served	Dana 2023 Sustainability & Social Responsibility Report: Overview / 2023 Sales Dana 2023 10-K pages 1 & 2	N/A
102-7	Scale of the organization	Dana 2023 Sustainability & Social Responsibility Report: Overview / 2023 Sales Dana 2023 10-K pages 3 & 4	N/A
102-8	Information on employees and other workers	Dana 2023 Sustainability & Social Responsibility Report: Overview / Employment Data Dana 2023 10-K pages 5 & 6	N/A
102-9	Supply chain	Dana 2023 Sustainability & Social Responsibility Report: Taking Action / Driving a World-Class Sustainable Supply Chain Dana 2023 10-K page 3	N/A
102-10	Significant changes to the organization and its supply chain	Dana 2023 Sustainability & Social Responsibility Report: Taking Action / Driving a World-Class Sustainable Supply Chain Dana 2023 10-K pages 9 - 10	N/A
102-11	Precautionary principle or approach	Dana has applied the precautionary principle in its approach to managing greenhouse gas emissions and their effect on global climate change.	N/A
102-12	External initiatives	Dana 2023 Sustainability & Social Responsibility Report: Appendix / Stakeholder Engagement	SDG 17
102-13	Membership of associations	Dana 2023 Sustainability & Social Responsibility Report: Appendix / Stakeholder Engagement	SDG 17

GLOBAL REPORTING INITIATIVE (GRI) INDEX

Disclosure Number	Disclosure Title	2023 Response	SDGs
Strategy			
102-14	Statement from senior decision-maker	Dana 2023 Sustainability & Social Responsibility Report: Message from the CEO	N/A
102-15	Key impacts, risks, and opportunities	Dana 2023 10-K , pages 7 - 13	N/A
Ethics and Integrity			
102-16	Values, principles, standards, and norms of behavior	Dana 2023 Sustainability & Social Responsibility Report: Culture Matters / Ethics and Integrity Standards of Business Conduct	SDG 3
102-17	Mechanisms for advice and concerns about ethics	Dana 2023 Sustainability & Social Responsibility Report: Culture Matters / Ethics and Integrity Internal Investigations Policy	SDG 16
Governance			
102-18	Governance structure	Dana 2023 Sustainability & Social Responsibility Report: Culture Matters / Leadership Technology & Sustainability Committee Sustainability & Social Responsibility Governance	SDG 16
102-19	Delegating authority	Technology & Sustainability Committee Sustainability & Social Responsibility Governance	SDG 16
102-20	Executive-level responsibility for economic, environmental, and social topics	Sustainability & Social Responsibility Governance	SDG 16
102-21	Consulting stakeholders on economic, environmental, and social topics	Dana 2023 Sustainability & Social Responsibility Report: Appendix / Methodology	SDG 16
102-22	Composition of the highest governance body and its committees	Board of Directors Corporate Governance Sustainability & Social Responsibility Governance Dana 2024 Proxy, page 50-51	SDG 16
102-23	Chair of the highest governance body	Dana 2024 Proxy , pages 39 - 41	SDG 16
102-24	Nominating and selecting the highest governance body	Corporate Governance Dana 2024 Proxy , pages 40-43 Director Selection and Retention Guidelines	SDG 16
102-25	Conflicts of interest	Standards of Business Conduct Policy for Members of the Board of Directors	SDG 16
102-26	Role of highest governance body in setting purpose, values, and strategy	Corporate Governance Guidelines	SDG 16
102-27	Collective knowledge of highest governance body	Dana Board of Directors Dana 2024 Proxy , pages 41-51	SDG 16
102-28	Evaluating the highest governance body's performance	Corporate Governance Guidelines , page 6 Dana 2024 Proxy , page 44-51	SDG 16
102-29	Identifying and managing economic, environmental, and social impacts	Technology & Sustainability Committee Charter , page 1, items 5 - 7 Sustainability & Social Responsibility Governance	SDG 16

GLOBAL REPORTING INITIATIVE (GRI) INDEX

Disclosure Number	Disclosure Title	2023 Response	SDGs
102-30	Effectiveness of risk management processes	Dana 2023 10-K , pages 7 - 13 Dana 2024 Proxy , page 45	SDG 16
102-31	Review of economic, environmental, and social topics	Sustainability & Social Responsibility Governance Dana 2024 Proxy , page 47	SDG 16
102-32	Highest governance body's role in sustainability reporting	Technology & Sustainability Committee Charter Sustainability & Social Responsibility Governance	SDG 16
102-33	Communicating critical concerns	Go to Dana.com to find the latest investor relations information about Dana, including stock quotes, news releases, and financial data. Requests for information may be directed to: Dana Incorporated Investor Relations P.O. Box 1000 Maumee, OH 43537, USA E-mail: InvestorRelations@dana.com / Dana's Investor Line: 800-537-8823 Through this 24-hour phone service, a caller may leave their name with a message, and the call will be returned by a Dana representative.	SDG 16
102-34	Nature and total number of critical concerns	This information is considered confidential.	SDG 16
102-35	Remuneration policies	Dana 2024 Proxy , pages 8 - 38	SDG 16
102-36	Process for determining remuneration	Dana 2024 Proxy , pages 8 - 38	SDG 16
102-37	Stakeholders' involvement in remuneration	Dana 2024 Proxy , page 54	SDG 16
102-38	Annual total compensation ratio	Dana 2024 Proxy , page 34	SDG 16
102-39	Percentage increase in annual total compensation ratio	Dana 2024 Proxy , page 34	SDG 16
Stakeholder Engagement			
102-40	List of stakeholder groups	Dana 2023 Sustainability & Social Responsibility Report: Appendix / Methodology	N/A
102-41	Collective bargaining agreements	Dana recognizes and supports freedom of association and collective bargaining rights as required by applicable law.	N/A
102-42	Identifying and selecting stakeholders	Dana 2023 Sustainability & Social Responsibility Report: Appendix / Methodology	N/A
102-43	Approach to stakeholder engagement	Dana 2023 Sustainability & Social Responsibility Report: Appendix / Methodology	N/A
102-44	Key topics and concerns raised	Dana 2023 Sustainability & Social Responsibility Report: Appendix / Methodology	N/A

GLOBAL REPORTING INITIATIVE (GRI) INDEX

Disclosure Number	Disclosure Title	2023 Response	SDGs
Reporting Practices			
102-45	Entities included in the consolidated financial statements	Dana 2023 10-K , page 14	N/A
102-46	Defining report content and topic Boundaries	Dana 2023 Sustainability & Social Responsibility Report: Appendix / Methodology	N/A
102-47	List of material topics	Dana 2023 Sustainability & Social Responsibility Report: Appendix / Methodology	N/A
102-48	Restatements of information	None	N/A
102-49	Changes in reporting	None	N/A
102-50	Reporting period	Dana 2023 Sustainability & Social Responsibility Report: Cover Page	N/A
102-51	Date of most recent report	April 2024	N/A
102-52	Reporting cycle	Dana 2023 Sustainability & Social Responsibility Report: Cover Page	N/A
102-53	Contact point for questions regarding the report	Please send any questions regarding the report to: sustainability@dana.com	N/A
102-54	Claims of reporting in accordance with the GRI Standards	Dana 2023 Sustainability & Social Responsibility Report: Appendix / GRI Content Index	N/A
102-55	GRI content index	Dana 2023 Sustainability & Social Responsibility Report: Appendix / GRI Content Index	N/A
102-56	External assurance	The Dana 2023 Sustainability & Social Responsibility Report has not been externally reviewed and verified as of the release date.	SDG 16
Topic-Specific Standards			
GRI 204: Procurement Practices			
103-1	Explanation of the material topic and its boundary	Dana 2023 Sustainability & Social Responsibility Report: Appendix / Methodology	N/A
103-2	The management approach and its components	Dana 2023 Sustainability & Social Responsibility Report: Taking Action / Driving a World-Class Sustainable Supply Chain	SDG 12
103-3	Evaluation of the management approach	Dana 2023 Sustainability & Social Responsibility Report: Taking Action / Driving a World-Class Sustainable Supply Chain	SDG 12
204-1	Proportion of spending on local suppliers	Dana works with thousands of suppliers around the world, including many suppliers located near our customers' operations.	SDG 12

GLOBAL REPORTING INITIATIVE (GRI) INDEX

Disclosure Number	Disclosure Title	2023 Response	SDGs
GRI 205: Anti-Corruption			
103-1	Explanation of the material topic and its boundary	Dana 2023 Sustainability & Social Responsibility Report: Appendix / Methodology	N/A
103-2	The management approach and its components	Dana 2023 Sustainability & Social Responsibility Report: Culture Matters / Ethics and Integrity	SDG 16
103-3	Evaluation of the management approach	Dana 2023 Sustainability & Social Responsibility Report: Culture Matters / Ethics and Integrity	SDG 16
205-1	Operations assessed for risks related to corruption	Dana has a robust internal audit program including audit procedures specifically focused on business conduct.	SDG 16
205-2	Communication and training about anti-corruption policies and procedures	Dana 2023 Sustainability & Social Responsibility Report: Culture Matters / Ethics and Integrity	SDG 16
205-3	Confirmed incidents of corruption and actions taken	Dana 2023 Sustainability & Social Responsibility Report: Culture Matters / Ethics and Compliance Hotline	SDG 16
GRI 206: Anti-Competitive Behavior			
103-1	Explanation of the material topic and its boundary	Dana 2023 Sustainability & Social Responsibility Report: Appendix / Methodology	N/A
103-2	The management approach and its components	Dana 2023 Sustainability & Social Responsibility Report: Culture Matters / Ethics and Integrity	SDG 16
103-3	Evaluation of the management approach	Dana 2023 Sustainability & Social Responsibility Report: Culture Matters / Ethics and Integrity	SDG 16
206-1	Legal actions for anti-competitive behavior, anti-trust, and monopoly practices	Dana's public filings would identify any significant pending proceedings.	SDG 16
GRI 302: Energy			
103-1	Explanation of the material topic and its boundary	Dana 2023 Sustainability & Social Responsibility Report: Appendix / Methodology	N/A
103-2	The management approach and its components	Dana 2023 Sustainability & Social Responsibility Report: Overview / Climate Action	SDG 12, 13
103-3	Evaluation of the management approach	Dana 2023 Sustainability & Social Responsibility Report: Overview / Climate Action	SDG 12, 13
302-1	Energy consumption within the organization	49.3% electricity purchased from traditional grid electricity providers Dana 2023 Sustainability & Social Responsibility Report: Overview / Climate Action and the graph detailing Total Energy Consumption (MWh)	SDG 7, 12, 13
302-2	Energy consumption outside of the organization	Scope 3 emissions for 2023 will be included in the 2024 CDP submission	SDG 7, 12, 13

GLOBAL REPORTING INITIATIVE (GRI) INDEX

Disclosure Number	Disclosure Title	2023 Response	SDGs
302-3	Energy intensity	<p>Dana 2022 Sustainability & Social Responsibility Report: Overview / Climate Action</p> <p>Total Energy Consumption (kWh) 2019: 2,025,519 kWh 2020: 1,736,158 kWh 2021: 1,866,837 kWh 2022: 1,840,509 kWh 2023: 1,817,941 kWh</p> <p>Normalized Energy Consumption (kWh per hour worked) 2019: 28.42 kWh per hour worked 2020: 27.89 kWh per hour worked 2021: 24.88 kWh per hour worked 2022: 23.22 kWh per hour worked 2023: 22.42 kWh per hour worked</p> <p>Normalized GHG Emissions (kWh per mil \$ sales) 2019: 234,979 kWh per mil \$ sales 2020: 244,323 kWh per mil \$ sales 2021: 208,702 kWh per mil \$ sales 2022: 181,224 kWh per mil \$ sales 2023: 172,236 kWh per mil \$ sales</p>	SDG 7, 12, 13
302-4	Reduction of energy consumption	Dana 2023 Sustainability & Social Responsibility Report: Overview / Climate Action and the graph detailing Total Energy Consumption (MWh)	SDG 7, 12, 13
302-5	Reduction in energy requirements of products and services	Dana 2023 Sustainability & Social Responsibility Report: Innovation	SDG 9, 13
GRI 303: Water & Effluents			
103-1	Explanation of the material topic and its boundary	Dana 2023 Sustainability & Social Responsibility Report: Appendix / Methodology	N/A
103-2	The management approach and its components	Dana 2023 Sustainability & Social Responsibility Report: Overview	SDG 12, 14
103-3	Evaluation of the management approach	Dana 2023 Sustainability & Social Responsibility Report: Overview	SDG 12, 14
303-1	Interactions with water as a shared resource	Water interactions for 2023 will be included in the 2024 CDP submission	SDG 12, 14
303-2	Management of water discharge-related impacts	Water discharge for 2023 will be included in the 2024 CDP submission	SDG 12, 14

GLOBAL REPORTING INITIATIVE (GRI) INDEX

Disclosure Number	Disclosure Title	2023 Response	SDGs
303-3	Water withdrawal	<p>Dana 2023 Sustainability & Social Responsibility Report: Overview</p> <p>Total Water Consumption (m³) 2019: 3,506,106 m³ 2020: 3,270,472 m³ 2021: 3,344,551 m³ 2022: 3,030,299 m³ 2023: 3,330,266 m³</p> <p>Total Normalized Water Consumption (m3 per hour worked) 2019: 0.0492 m³ per hour worked 2020: 0.0525 m³ per hour worked 2021: 0.0446 m³ per hour worked 2022: 0.0382 m³ per hour worked 2023: 0.0411 m³ per hour worked</p> <p>Total Normalized Water Consumption (m3 per mil \$ sales) 2019: 407 m³ per mil \$ sales 2020: 460 m³ per mil \$ sales 2021: 374 m³ per mil \$ sales 2022: 298 m³ per mil \$ sales 2023: 316 m³ per mil \$ sales</p>	SDG 6, 12, 14
303-4	Water discharge	Water discharge for 2023 will be included in the 2024 CDP submission	SDG 12, 14
303-5	Water consumption	Water consumption for 2023 will be included in the 2024 CDP submission	SDG 6, 12, 14
GRI 305: Emissions			
103-1	Explanation of the material topic and its boundary	Dana 2023 Sustainability & Social Responsibility Report: Appendix / Methodology	N/A
103-2	The management approach and its components	Dana 2023 Sustainability & Social Responsibility Report: Overview / Climate Action	SDG 7, 12, 13
103-3	Evaluation of the management approach	Dana 2023 Sustainability & Social Responsibility Report: Overview / Climate Action	SDG 7, 12, 13
305-1	Energy: Direct (Scope 1) GHG emissions	<p>Dana 2023 Sustainability & Social Responsibility Report: Overview / Climate Action</p> <p>Scope 1 GHG Emissions (kg CO₂-e): 2019: 162,407,000 kg 2020: 133,223,000 kg 2021: 145,236,000 kg 2022: 142,868,991 kg 2023: 135,503,446 kg</p> <p>2023 Scope 1 Energy Consumption by Type (MWh): Natural Gas: 632,479 MWh LPG: 48,674 MWh Diesel: 8,412 MWh Gasoline: 446 MWh</p>	SDG 7, 12, 13

GLOBAL REPORTING INITIATIVE (GRI) INDEX

Disclosure Number	Disclosure Title	2023 Response	SDGs
305-2	Energy: Indirect (Scope 2) GHG emissions	<p>Dana 2023 Sustainability & Social Responsibility Report: Overview / Climate Action</p> <p>Scope 2 GHG Emissions (kg CO₂-e) 2019: 455,435,000 kg 2020: 388,347,000 kg 2021: 401,322,000 kg 2022: 355,339,692 kg 2023: 243,361,512 kg</p> <p>2023 Scope 2 Energy Consumption by Type (MWh) Grid Electricity: 556,158 MWh Renewable Electricity: 571,781 MWh</p>	SDG 7, 12, 13
305-3	Energy: Other indirect (Scope 3) GHG emissions	Scope 3 emissions information for 2023 will be included in the 2024 CDP submission.	SDG 7, 12, 13
305-4	GHG emissions intensity	<p>Dana 2023 Sustainability & Social Responsibility Report: Overview / Climate Action</p> <p>Normalized GHG Emissions (kg CO₂-e per hour worked) 2019: 8.67 kg CO₂-e per hour worked 2020: 8.38 kg CO₂-e per hour worked 2021: 7.28 kg CO₂-e per hour worked 2022: 6.29 kg CO₂-e per hour worked 2023: 4.67 kg CO₂-e per hour worked</p> <p>Normalized GHG Emissions (kg CO₂ -e per mil \$ sales) 2019: 71,675 kg CO₂ -e per mil \$ sales 2020: 73,399 kg CO₂ -e per mil \$ sales 2021: 61,102 kg CO₂ -e per mil \$ sales 2022: 49,056 kg CO₂ -e per mil \$ sales 2023: 35,894 kg CO₂ -e per mil \$ sales</p>	SDG 7, 12, 13
305-5	Reduction of GHG emissions	Dana 2023 Sustainability & Social Responsibility Report: Overview / Climate Action and graph detailing Total Greenhouse Gas Emissions (kg CO ₂ -e)	SDG 7, 12, 13
305-6	Emissions of ozone-depleting substances (ODS)	8,347,487 kg included in the calculation for Scope 1 GHG emissions	SDG 7, 12, 13
305-7	Nitrogen oxides (NOx), sulfur oxides (SOx), and other significant air emissions	<p>Significant emissions from combustion of fuels in 2023, include:</p> <p>Particulate Matter: 11,975 kg Nitrogen Oxides: 165,217 kg Sulfur Oxides: 4,410 kg Carbon Monoxide: 99,844 kg Volatile Organic Compounds: 13,014 kg Hazardous Air Pollutants: 35 kg</p> <p>Calculation Source: AP-42 Fifth Edition, Tables 3.3-1, 10/96 Update</p>	SDG 12, 13

GLOBAL REPORTING INITIATIVE (GRI) INDEX

Disclosure Number	Disclosure Title	2023 Response	SDGs
GRI 306: Effluents and Waste			
103-1	Explanation of the material topic and its boundary	Dana 2023 Sustainability & Social Responsibility Report: Appendix / Methodology	N/A
103-2	The management approach and its components	Dana 2023 Sustainability & Social Responsibility Report: Taking Action	SDG 12, 15
103-3	Evaluation of the management approach	Dana 2023 Sustainability & Social Responsibility Report: Taking Action	SDG 12, 15
306-1	Waste generation and significant waste-related impacts	Dana 2023 Sustainability & Social Responsibility Report: Taking Action 2023 Hazardous Waste by Treatment Method (kg) is being calculated 2023 Non-Hazardous Waste by Treatment Method (kg) is being calculated	SDG 12, 15
306-2	Management of significant waste-related impacts	Dana 2023 Sustainability & Social Responsibility Report: Taking Action Refer to 2023 Hazardous and Non-Hazardous Waste Data (above)	SDG 12, 15
306-3	Waste generated	Dana 2023 Sustainability & Social Responsibility Report: Taking Action Refer to 2023 Hazardous and Non-Hazardous Waste Data (above)	SDG 12, 15
306-4	Waste diverted from disposal	Dana 2023 Sustainability & Social Responsibility Report: Taking Action Refer to 2023 Hazardous and Non-Hazardous Waste Data (above)	SDG 12, 15
306-5	Waste directed to disposal	Dana 2023 Sustainability & Social Responsibility Report: Taking Action Refer to 2023 Hazardous and Non-Hazardous Waste Data (above)	SDG 12, 15
GRI 307: Environmental Compliance			
103-1	Explanation of the material topic and its boundary	Dana 2023 Sustainability & Social Responsibility Report: Appendix / Methodology	N/A
103-2	The management approach and its components	Dana 2023 Sustainability & Social Responsibility Report: Value Others / Safety First	SDG 13, 14, 15, 16
103-3	Evaluation of the management approach	Dana 2023 Sustainability & Social Responsibility Report: Value Others / Safety First	SDG 13, 14, 15, 16
307-1	Non-compliance with environmental laws and regulations	No significant fines and/or non-monetary sanctions were levied against any of our sites in 2023. Dana 2023 10-K , page 7	SDG 13, 14, 15, 16
GRI 308: Supplier Environmental Assessment			
103-1	Explanation of the material topic and its boundary	Dana 2023 Sustainability & Social Responsibility Report: Appendix / Methodology	N/A
103-2	The management approach and its components	Dana 2023 Sustainability & Social Responsibility Report: Taking Action / Driving a World-Class Sustainable Supply Chain	SDG 12, 16
103-3	Evaluation of the management approach	Dana 2023 Sustainability & Social Responsibility Report: Taking Action / Driving a World-Class Sustainable Supply Chain	SDG 12, 16
308-1	New suppliers that were screened using the environmental criteria	Dana 2023 Sustainability & Social Responsibility Report: Taking Action / Driving a World-Class Sustainable Supply Chain	SDG 12, 16
308-2	Negative environmental impacts in the supply chain and actions taken	Dana 2023 Sustainability & Social Responsibility Report: Taking Action / Driving a World-Class Sustainable Supply Chain	SDG 12, 16

GLOBAL REPORTING INITIATIVE (GRI) INDEX

Disclosure Number	Disclosure Title	2023 Response	SDGs
GRI 401: Employment			
103-1	Explanation of the material topic and its boundary	Dana 2023 Sustainability & Social Responsibility Report: Appendix / Methodology	N/A
103-2	The management approach and its components	Dana 2023 Sustainability & Social Responsibility Report: Overview / Employment Data	SDG 8
103-3	Evaluation of the management approach	Dana 2023 Sustainability & Social Responsibility Report: Overview / Employment Data	SDG 8
401-1	New employee hires and employee turnover	Dana 2023 Sustainability & Social Responsibility Report: Overview / Employment Data	SDG 8
401-2	Benefits provided to full-time employees that are not provided to temporary or part-time employees	Dana 2023 Sustainability & Social Responsibility Report: Value Others / Health and Wellbeing Spotlight Dana 2023 10-K , pages 5 & 6 Careers Website	SDG 3, 8
401-3	Parental leave	This information is being collected and analyzed.	SDG 3, 8
GRI 403: Occupational Health & Safety			
103-1	Explanation of the material topic and its boundary	Dana 2023 Sustainability & Social Responsibility Report: Appendix / Methodology	N/A
103-2	The management approach and its components	Dana 2023 Sustainability & Social Responsibility Report: Value Others / Safety First	SDG 3, 8
103-3	Evaluation of the management approach	Dana 2023 Sustainability & Social Responsibility Report: Value Others / Safety First	SDG 3, 8
403-1	Occupational health and safety management system	Dana 2023 Sustainability & Social Responsibility Report: Value Others / ISO 45001 Certification Goal Achieved	SDG 3, 8
403-2	Hazard identification, risk assessment, and incident investigation	Dana 2023 Sustainability & Social Responsibility Report: Value Others / ISO 45001 Certification Goal Achieved By December 2022, all major manufacturing sites had achieved certification to the ISO 45001. Organizations that implement ISO 45001 need: a clear management structure with defined authority and responsibility. defined objectives for improvement, with measurable results. a structured approach to risk assessment and reduction.	SDG 3, 8
403-3	Occupational health services	Dana facilities maintain robust occupational health services while also protecting worker confidential information.	SDG 3, 8
403-4	Worker participation, consultation, and communication on occupational health and safety	Dana 2023 Sustainability & Social Responsibility Report: Value Others / ISO 45001 Certification Goal Achieved By December 2022, all major manufacturing sites had achieved certification to the ISO 45001. Organizations that implement ISO 45001 need: a clear management structure with defined authority and responsibility. defined objectives for improvement, with measurable results. a structured approach to risk assessment and reduction.	SDG 3, 8
403-5	Worker training on occupational health and safety	Dana 2023 Sustainability & Social Responsibility Report: Value Others / EHSS Education Drive By December 2022, all major manufacturing sites had achieved certification to the ISO 45001. Organizations that implement ISO 45001 need: a clear management structure with defined authority and responsibility. defined objectives for improvement, with measurable results. a structured approach to risk assessment and reduction.	SDG 3, 8

GLOBAL REPORTING INITIATIVE (GRI) INDEX

Disclosure Number	Disclosure Title	2023 Response	SDGs
403-6	Promotion of worker health	Dana 2023 Sustainability & Social Responsibility Report: Value Others / Safety First Dana 2023 Sustainability & Social Responsibility Report: Value Others / Health and Wellbeing Spotlight	SDG 3, 8
403-7	Prevention and mitigation of occupational health and safety impacts	Dana 2023 Sustainability & Social Responsibility Report: Value Others / Safety First	SDG 3, 8
403-8	Workers covered by an occupational health and safety management system	Dana 2023 Sustainability & Social Responsibility Report: Value Others / ISO 45001 Certification Goal Achieved	SDG 3, 8
403-9	Work-related injuries	Dana 2023 Sustainability & Social Responsibility Report: Value Others / Safety First and graphs detailing Lost Time Recordable and Recordable Incident Rates	SDG 3, 8
403-10	Work-related ill health	Dana 2023 Sustainability & Social Responsibility Report: Value Others / Safety First and graphs detailing Lost Time Recordable and Recordable Incident Rates	SDG 3, 8
GRI 404: Training and Education			
103-1	Explanation of the material topic and its boundary	Dana 2023 Sustainability & Social Responsibility Report: Appendix / Methodology	N/A
103-2	The management approach and its components	Dana 2023 Sustainability & Social Responsibility Report: Value Others / People Development	SDG 4, 8
103-3	Evaluation of the management approach	Dana 2023 Sustainability & Social Responsibility Report: Value Others / People Development	SDG 4, 8
404-1	Average hours of training per year per employee	Dana 2023 Sustainability & Social Responsibility Report: Value Others / EHSS Education Drive and People Development	SDG 4, 8
404-2	Programs for upgrading employee skills and transition assistance programs	Dana 2023 Sustainability & Social Responsibility Report: Value Others / People Development	SDG 4, 8
404-3	Percentage of employees receiving regular performance and career development reviews	Dana 2023 Sustainability & Social Responsibility Report: Value Others / People Development	SDG 4, 8
GRI 405: Diversity & Equal Opportunity			
103-1	Explanation of the material topic and its boundary	Dana 2023 Sustainability & Social Responsibility Report: Appendix / Methodology	N/A
103-2	The management approach and its components	Dana 2023 Sustainability & Social Responsibility Report: Value Others / Diversity, Equity, and Inclusion	SDG 5, 8, 10
103-3	Evaluation of the management approach	Dana 2023 Sustainability & Social Responsibility Report: Value Others / Diversity, Equity, and Inclusion	SDG 5, 8, 10
405-1	Diversity of governance bodies and employees	Dana 2023 Sustainability & Social Responsibility Report: Value Others / Diversity, Equity, and Inclusion and Employment Data Board of Directors Dana 2024 Proxy , page 46	SDG 5, 8, 10
405-2	Ratio of basic salary and remuneration of women to men	This information is being collected and analyzed.	SDG 5, 8, 10

GLOBAL REPORTING INITIATIVE (GRI) INDEX

Disclosure Number	Disclosure Title	2023 Response	SDGs
GRI 406: Non-Discrimination			
103-1	Explanation of the material topic and its boundary	Dana 2023 Sustainability & Social Responsibility Report: Appendix / Methodology	N/A
103-2	The management approach and its components	Dana 2023 Sustainability & Social Responsibility Report: Value Others / Diversity, Equity, and Inclusion	SDG 5, 8, 10
103-3	Evaluation of the management approach	Dana 2023 Sustainability & Social Responsibility Report: Value Others / Diversity, Equity, and Inclusion	SDG 5, 8, 10
406-1	Incidents of discrimination and corrective actions taken	Dana 2023 Sustainability & Social Responsibility Report: Culture Matters / Ethics and Integrity	SDG 5, 8, 10, 16
GRI 414: Supplier Social Assessment			
103-1	Explanation of the material topic and its boundary	Dana 2023 Sustainability & Social Responsibility Report: Appendix / Methodology	N/A
103-2	The management approach and its components	Dana 2023 Sustainability & Social Responsibility Report: Taking Action / Driving a World-Class Sustainable Supply Chain	SDG 12
103-3	Evaluation of the management approach	Dana 2023 Sustainability & Social Responsibility Report: Taking Action / Driving a World-Class Sustainable Supply Chain	SDG 12
414-1	New suppliers that were screened using the social criteria	Dana 2023 Sustainability & Social Responsibility Report: Taking Action / Driving a World-Class Sustainable Supply Chain	SDG 12
Material Topic: Innovation and Product Lifecycle Management			
103-1	Explanation of the material topic and its boundary	Dana 2023 Sustainability & Social Responsibility Report: Appendix / Methodology	N/A
103-2	The management approach and its components	Dana 2023 Sustainability & Social Responsibility Report: Innovation	SDG 8, 9, 13
103-3	Evaluation of the management approach	Dana 2023 Sustainability & Social Responsibility Report: Innovation	SDG 8, 9, 13
Misc.	Innovation	Dana 2023 Sustainability & Social Responsibility Report: Innovation Dana 2023 10-K , page 5 (Engineering and Research and Development) Innovation and Technology Markets e-Mobility	SDG 8, 9, 13
Misc.	Product Lifecycle Management	The information is being collected and will be reported at a later date	SDG 8, 9, 13

SASB INDEX

The Sustainability Accounting Standards Board (SASB) is an independent nonprofit organization that sets standards to guide the disclosure of financially material sustainability information by companies to their investors. SASB Standards identify the subset of environmental, social, and governance (ESG) issues most relevant to financial performance.

Disclosure Number	Disclosure Name	2023 Response	SDGs
Energy Management			
TR-AP 130a.1.1	Total energy Consumption in gigajoules (GJ)	6,544,616 GJ in 2023; 1.2% decrease from 2022	SDG 7, 12, 13
TR-AP 130a.1.2	Percentage of grid electricity consumed	49.3% in 2023	SDG 7, 12, 13
TR-AP 103a.1.3	Percentage of renewable energy consumed	50.7% in 2023; Dana has installed solar panels at several facilities, entered into an agreement with the Toledo Community Foundation to purchase electricity from a newly constructed solar array, commenced a long-term virtual power purchase agreement with NextEra Energy generating ~325,000 MWh of renewable electricity annually beginning December 2022, and purchased I-RECs for majority of Brazil electricity consumption. Dana 2023 Sustainability & Social Responsibility Report: Overview / Climate Action	SDG 7, 12, 13
Waste Management			
TR-AP 150a.1.1	Total amount of waste generated in metric tons (MT)	Total waste generation is currently being calculated	SDG 12, 15
TR-AP 150a.1.2	Percentage of waste generated that was hazardous	Hazardous waste percentage is currently being calculated	SDG 12, 15
TR-AP 150a.1.3	Percentage of waste generated that was recycled	Recycled waste percentage is currently being calculated	SDG 12, 15
Product Safety			
TR-AP 250a.1.1	Total number of recalls issued	Dana had two (2) voluntary recalls in 2023	SDG 9, 16
TR-AP 250.a.1.2	Total number of units that were subject to a recall	Total number of units that were subject to recalls were 2,257	SDG 9, 16
Design for Fuel Efficiency			
TR-AP 410a.1.1	Total revenue from products that are designed to increase fuel efficiency and/or reduce emissions during their use	Dana 2023 Annual Report , page 6	SDG 8, 9, 13

SASB INDEX

Disclosure Number	Disclosure Name	2023 Response	SDGs
Materials Sourcing			
TR-AP 440a.1.1	Strategic approach to managing risks associated with the use of critical materials in products	Dana does not use any of the critical materials listed in the standard. Dana has a policy and process to manage identified Conflict Minerals. Dana 2023 Sustainability & Social Responsibility Report: Culture Matters	SDG 9, 10, 12
TR-AP 440a.1.2	Identify the critical materials that present a significant risk to operations	Dana does not use any of the critical materials listed in the standard. Dana has a policy and process to manage identified Conflict Minerals. Dana 2023 Sustainability & Social Responsibility Report: Culture Matters	SDG 9, 10, 12
TR-AP 440a.1.3	Disclosure sufficient for the risk without compromising confidential information	Dana does not use any of the critical materials listed in the standard. Dana has a policy and process to manage identified Conflict Minerals. Dana 2023 Sustainability & Social Responsibility Report: Culture Matters	SDG 9, 10, 12
Materials Efficiency			
TR-AP 440b.1.1	Percentage of products sold, by revenue, that are recyclable	The information is being collected and will be reported at a later date.	SDG 9, 12
TR-AP 440b.1.2	Percentage calculated as the revenue from products sold that are recyclable divided by the revenue from all products sold		SDG 9, 12
TR-AP 440b.1.3	Limit to products that are automotive parts, components, and materials		SDG 9, 12
TR-AP 440b.2.1	Percentage of input materials that are derived from recycled or remanufactured content		SDG 9, 12
TR-AP 440b.2.2	Percentage calculated as the weight of input materials consumed derived from recycled or remanufactured content divided by the total weight of all input materials consumed		SDG 9, 12
Competitive Behavior			
TR-AP 520a.1.1	Total amount of monetary losses incurred during the reporting period as a result of legal proceedings associated with anti-competitive behavior regulations	Dana's public filings would identify any significant monetary losses.	SDG 9, 16
TR-AP 520a.1.2	Any adjudicative proceeding before a court, a regulator, an arbitrator, or otherwise	Dana's public filings would identify any significant pending proceedings.	SDG 9, 16
TR-AP 520a.1.3	Losses, including any monetary liabilities to the opposing parties or others, fines and other monetary liabilities incurred during the reporting period as a result of civil actions, regulatory proceedings, and criminal actions	Dana's public filings outline its financial status including recurring and non-recurring items. Any significant losses will be identified in this information.	SDG 9, 16
TR-AP 520a.1.4	Scope of monetary losses excluding legal and other fees and expenses incurred in its defense	Dana's public filings outline its financial status including recurring and non-recurring items. Any significant losses will be identified in this information.	SDG 9, 16
TR-AP 520a.1.5	Scope of the disclosure, including legal proceedings associated with the enforcement of relevant regulations	Dana's public filings outline its financial status including recurring and non-recurring items. Any significant losses will be identified in this information.	SDG 9, 16
TR-AP 520a.1.6	Scope of the disclosure, including legal proceedings associated with enforcement of relevant industry regulations promulgated by regional, national, state, and local regulatory authorities	Dana's public filings outline its financial status including recurring and non-recurring items. Any significant losses will be identified in this information.	SDG 9, 16

TCFD INDEX

The Financial Stability Board established the Task Force on Climate-related Financial Disclosures (TCFD) to develop recommendations for more effective climate-related disclosures that could promote more informed investment, credit, and insurance underwriting decisions and, in turn, enable stakeholders to understand better the concentrations of carbon-related assets in the financial sector and the financial system’s exposures to climate-related risks.

Recommended Disclosure	2023 Response	SDGs
Governance		
a) Describe the Board’s oversight of climate-related risks and opportunities.	CDP Climate Change 2023 Report, Section C1.1 C1.1: Board committees have expanded oversight to include environmental, social and governance (ESG) issues receiving sustainability updates on all ESG issues, including climate change. On July 28, 2020, Dana Incorporated announced that its Board of Directors has established a standing Technology and Sustainability Committee focused on technological and environmental stewardship. The Technology and Sustainability Committee is responsible for assisting the Board with oversight relating to innovation, new technologies, potential information security risks, and sustainability and social responsibility. Key areas of focus for the Committee include the strategy, implementation, and effectiveness of Dana’s research and development initiatives, emerging trends in science, technology, and related regulations, strategic approach to technical talent management, cybersecurity protections, and sustainability and social responsibility activities. More information can be found at: https://www.dana.com/newsroom/press-releases/dana-incorporated-board-of-directors-establishes-technology-and-sustainability-committee/	SDG 7, 12, 13
b) Describe management’s role in assessing and managing climate-related risks and opportunities.	CDP Climate Change 2023 Report, Section C1.2 Sustainability & Social Responsibility Governance	SDG 7, 12, 13
Strategy		
a) Describe the climate-related risks and opportunities the organization has identified over the short, medium, and long term.	CDP Climate Change 2023 Report, Section C2.1 through C2.4	SDG 7, 12, 13
b) Describe the impact of climate-related risks and opportunities on the organization’s businesses, strategy, and financial planning.	CDP Climate Change 2023 Report, Section C2.1 through C2.4	SDG 7, 12, 13
c) Describe the resilience of the organization’s strategy, taking into consideration different climate-related scenarios, including 2°C or lower scenario.	This information will be included in the 2024 CDP submission.	SDG 7, 12, 13
Risk Management		
a) Describe the organization’s processes for identifying and assessing climate-related risks.	CDP Climate Change 2023 Report, Section C2.2 and C2.3	SDG 7, 12, 13
b) Describe the organization’s processes for managing climate-related risks.	CDP Climate Change 2023 Report, Section C2.2 and C2.3	SDG 7, 12, 13
c) Describe how processes for identifying, assessing, and managing climate-related risks are integrated into the organization’s overall risk management.	CDP Climate Change 2022 Report, Section C2.2 and C2.3	SDG 7, 12, 13

TCFD INDEX

Recommended Disclosure	2023 Response	SDGs
Metrics and Targets		
a) Disclose the metrics used by the organization to assess climate-related risks and opportunities in line with its strategy and risk management process.	CDP Climate Change 2023 Report, Section C4.1	SDG 7, 12, 13
b) Disclose Scope 1, Scope 2, and if appropriate, Scope 3 greenhouse gas (GHG) emissions, and the related risks.	<p>Dana 2023 Sustainability & Social Responsibility Report: Overview / Climate Action</p> <p>Scope 1 GHG Emissions (kg CO₂-e): 2019: 162,407,000 kg 2020: 133,223,000 kg 2021: 145,236,000 kg 2022: 142,868,991 kg 2023: 135,503,446 kg</p> <p>2023 Scope 1 Energy Consumption by Type (MWh): Natural Gas: 632,479 MWh LPG: 48,674 MWh Diesel: 8,412 MWh Gasoline: 446 MWh</p> <p>Scope 2 GHG Emissions (kg CO₂-e) 2019: 455,435,000 kg 2020: 388,347,000 kg 2021: 401,322,000 kg 2022: 355,339,692 kg 2023: 243,361,512 kg</p> <p>2023 Scope 2 Energy Consumption by Type (MWh) Grid Electricity: 556,151 MWh Renewable Electricity: 571,781 MWh</p>	SDG 7, 12, 13
c) Describe the targets used by the organization to manage climate-related risks and opportunities and performance against targets.	CDP Climate Change 2023 Report, Section C4.1	SDG 7, 12, 13
Transportation Group Metrics		
a) Revenues/savings from investments in low-carbon alternatives (e.g. R&D, equipment, products or services)	This information will be included in the 2024 CDP submission.	SDG 7, 12, 13



People Finding A Better Way[®]